

# Juuka 70

---

## Installation drawings



Marking			Length	pcs	
	Wall logs 70x146	<b>Molde 70</b>			
NP-1	70x70 Corner Post	<b>Molde 70</b>	2048	1	
	Hitting Block			3	



KL-1	Roof boards 24x120 MT10		2028	88+4	
RL-2	45x45 Roof moulding framing		4882	2	
PP-1	15x55 Floor and base boards		~4,5	12	
RL-1	18x95 Roof Moulding		~4,9	4	

LL-1	STP 14x121 Sauna room ceiling paneling		1596	17+3	
LR-1	15x55 Distance board for sauna ceiling		1797	4	
LR-2	45x45 Ceiling framing		1596	5	
PL-1	24x120 Floor boards (Front room)		2465	20+2	
PL-2	24x120 Floor boards (Sauna room)		1560	32+2	
TL-1	28x120 Decking boards		800	19+1	
<i>*Decking boards are delivered +25mm oversize, cut to length on site</i>					
AR-1	45x95 Floor Frame		4144	11	
AR-2	45x95 Floor Frame		3360	1	
AR-2B	45x95 Floor Frame	<i>Drawing</i>	3360	1	
AR-3	45x95 Floor Frame		2319	1	
AR-4	45x95 Floor Frame		2274	3	
AR-5	45x95 Floor Frame		1825	2	
AR-7	45x95 Floor Frame		788	1	
AR-6	<b>45x70</b> Floor Frame	<i>45x70</i>	1825	2	

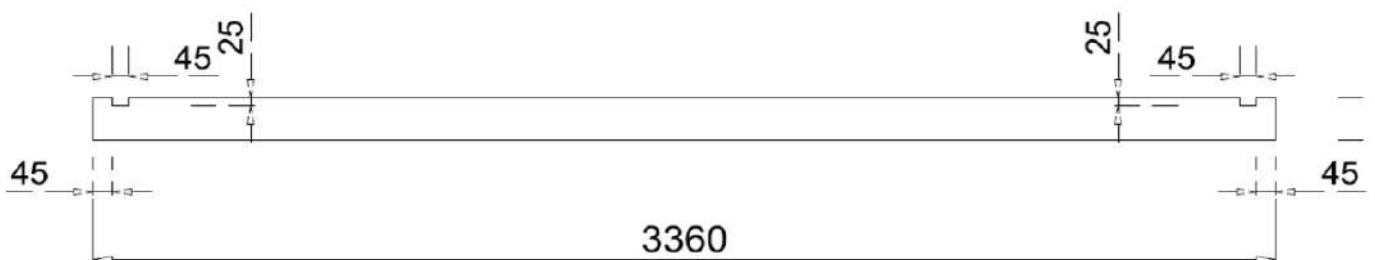

A-1	Window <b>70</b> x1100x540			<b>2</b>	
U-1	Front door <b>70</b> x <b>1300</b> x1860			1	
U-2	Glass door <b>70</b> x590x1860 Bronze			2	

TE-1	28x70 + 25x25 "T" Shape fillet		1860	6	
TE-2	28x70 + 25x25 "T" Shape fillet		540	4	

UK-1	18x95 Door Moulding		1890	12	
UK-2	18x95 Door Moulding		1520	2	
UK-3	18x95 Door Moulding		790	4	
UK-4	15x <b>55</b> Door Moulding		1290	2	
UK-5	15x <b>55</b> Door Moulding		560	4	
EXTRA	18x95 Door Moulding		~2400	1	

AK-1	18x95 Window Mouldings (1100x540 window)	set	1310	4	
AK-2	18x95 Window Mouldings (1100x540 window)		1060	4	
AK-3	18x95 Window Mouldings (1100x540 window)		625	8	

	Sauna Bench 500x1792			1	
	Sauna Bench 300x1792			1	
	Sauna Bench 500x1092			1	
	Sauna Bench 200x857			1	
	Bench 500x1592 front room			1	
	Bench support set 45x45			1	
LT-1	45x45 Bench vertical support + adjustable leg M10		850	1	

RN-1	Water drainage detail	<b>1800 +</b>		1	
RN-2	Water drainage detail	<b>1800 +</b>		1	
	3MM SLOPE DETAIL UNDER FLOOR BOARDS		1795	2	
	6MM SLOPE DETAIL UNDER FLOOR BOARDS		1795	2	
	9MM SLOPE DETAIL UNDER FLOOR BOARDS		1795	2	
	12MM SLOPE DETAIL UNDER FLOOR BOARDS		1795	2	

	SPU INSULATION 30x600x1200	SAUNA CEILING		5	
--	----------------------------	---------------	--	---	--

	Threaded rod M10		2465	1	
	Threaded rod M10		2325	5	
	<b>LENGTHENING</b> bolt M10			6	
	Drive nut M10			6	
	Washer M10			6	
	Nut M10			6	
	Bolt for Post 60x60			1	
	Screw 3,5x40 Mouldings			200	
	Screw 4,2x55 Decking boards, Roof Mouldings			200	
	Screw 3,5x50 Floor Boards			500	
	Screw 4,5x60 Roof boards			200	
	Screw 4,5x80 Bench supports/ post			100	
	Screw 5,0x90 <b>ASSY</b> Floor Frame, Wall logs			200	
	Screw 6x180 Wall logs			100	
	Metal Angle Bracket 40x40 for Ceiling framing			12	
	Screw 5x40 for metal angle bracket			100	
	Roof nails 75 MM			~1500	
	Ceiling paneling nails 40 MM			~300	
	Foil Tape			1	
	VENTILATION LOUVER WOOD			3	
	VENTILATION GRID METAL			3	
	Installation Drawings				

# Floor plan

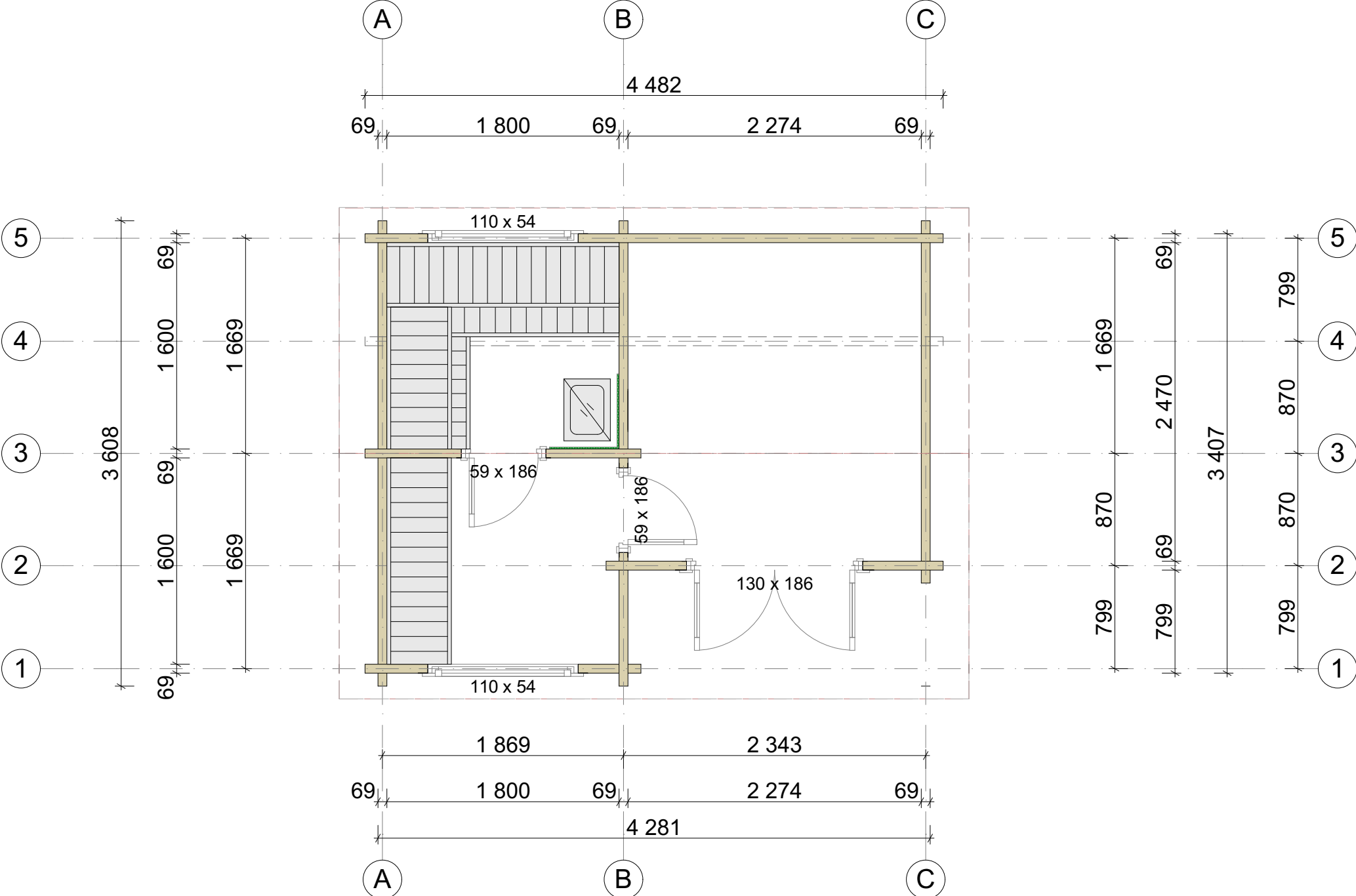

# Cross section

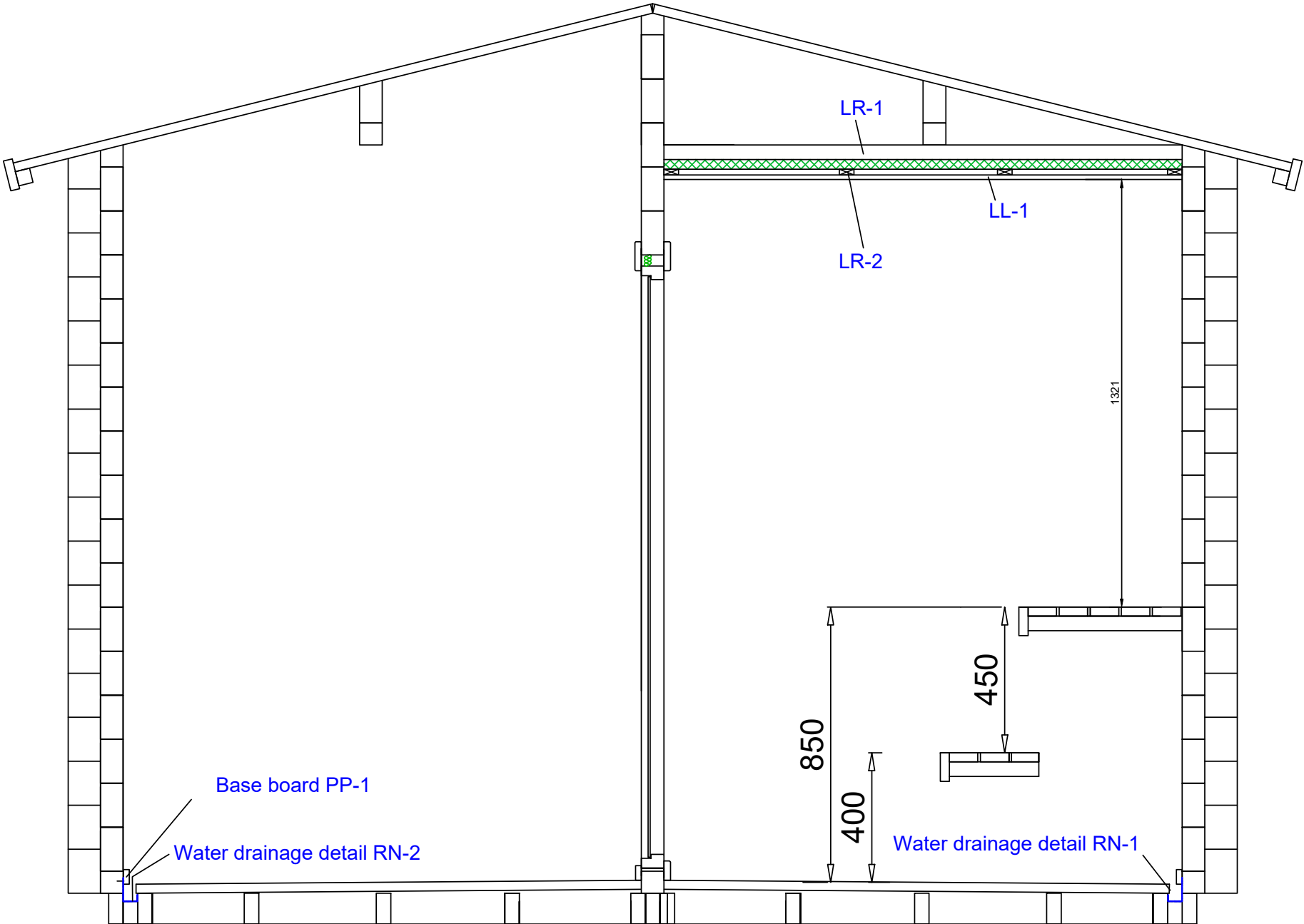





# Floor frame

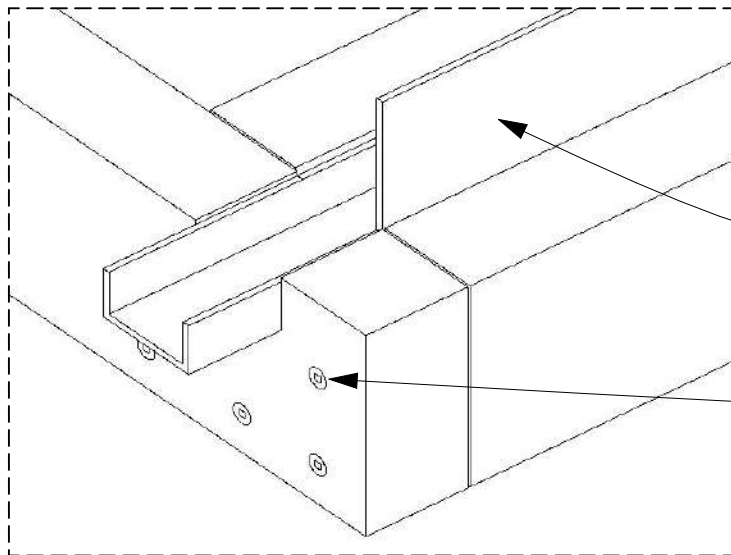
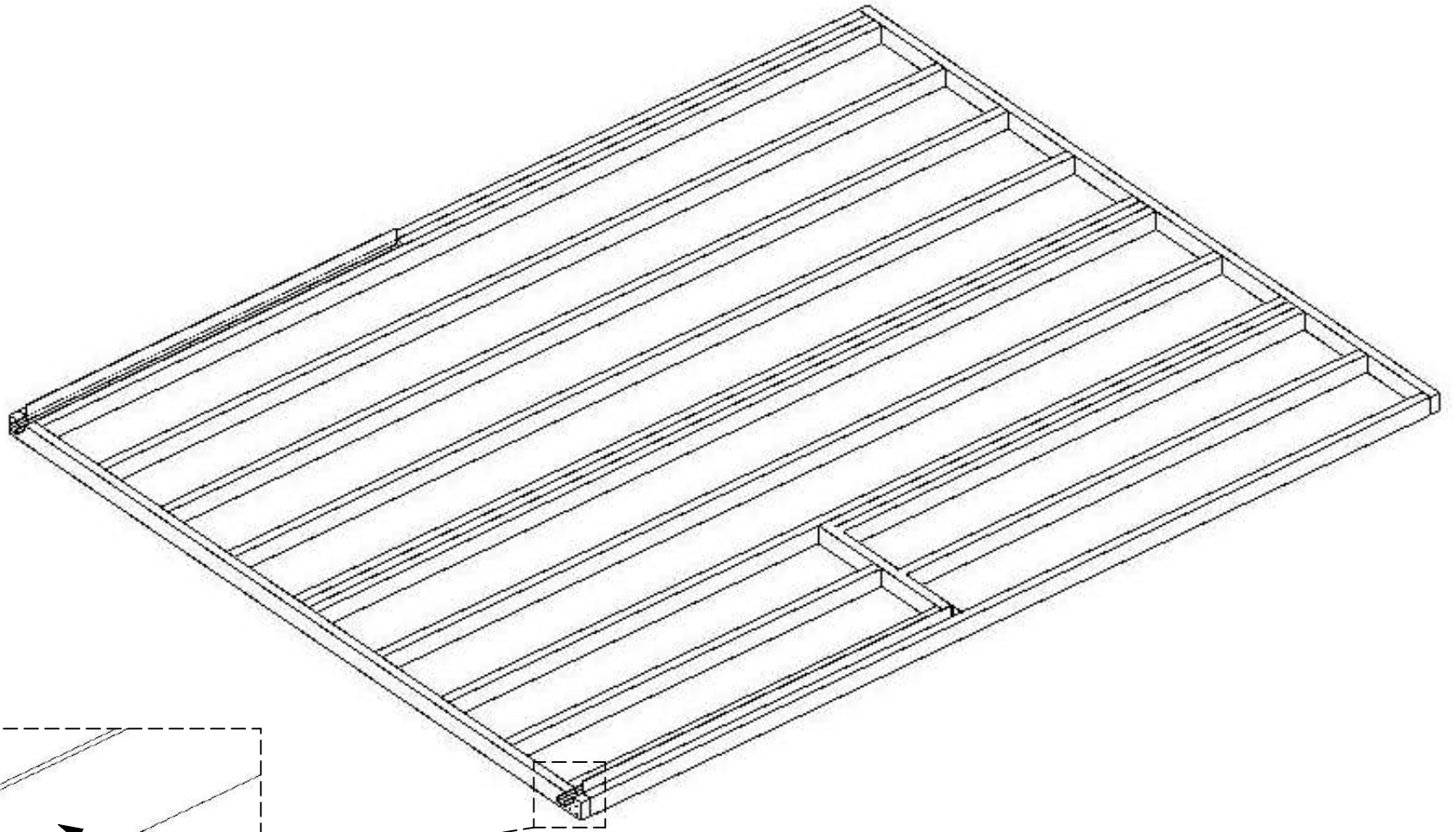

Water drainage detail

Screws 90mm

**Install water drainage detail before first wall log**

\* Use 90mm screws



**TAKE CARE! WATER DRAINAGE DETAIL HAS SHARP EDGES!**

# Floor boards

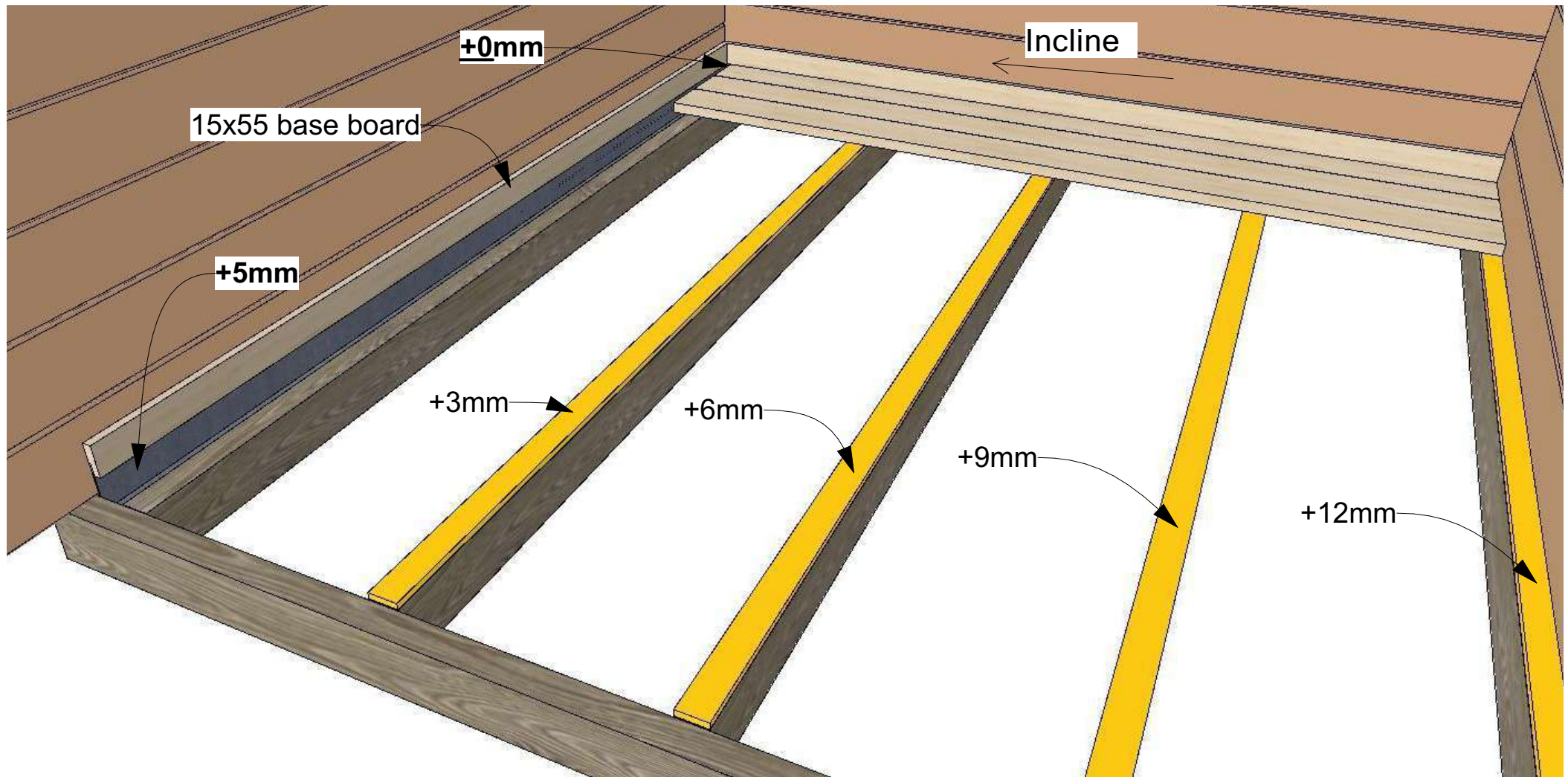

1. Attach slope details to give floor boards incline
2. Install water drainage detail +5mm to give incline
3. Attach base board 15x55 to water drainage detail to fix water drainage detail to wall

# Floor- and decking boards

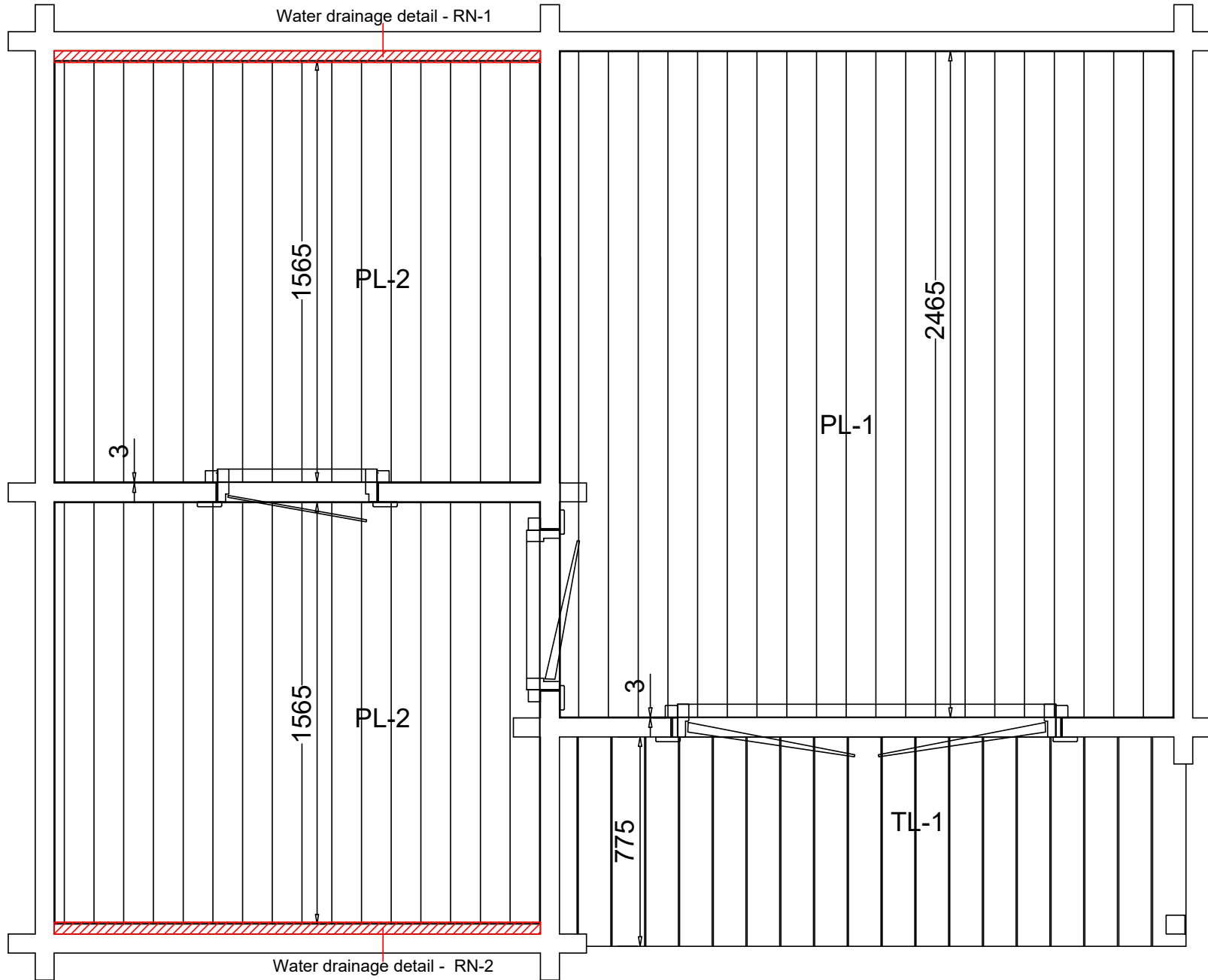

**Install Floor boards with 50mm screws**



**Install Decking boards with 55mm screws (leave 5mm cap)**

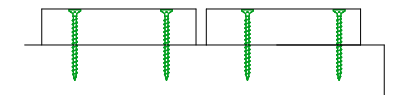

# First log wall row

Install first log wall row to the floor frame with 90mm and 180mm screws(Suggestion: Drill hole before screwing)

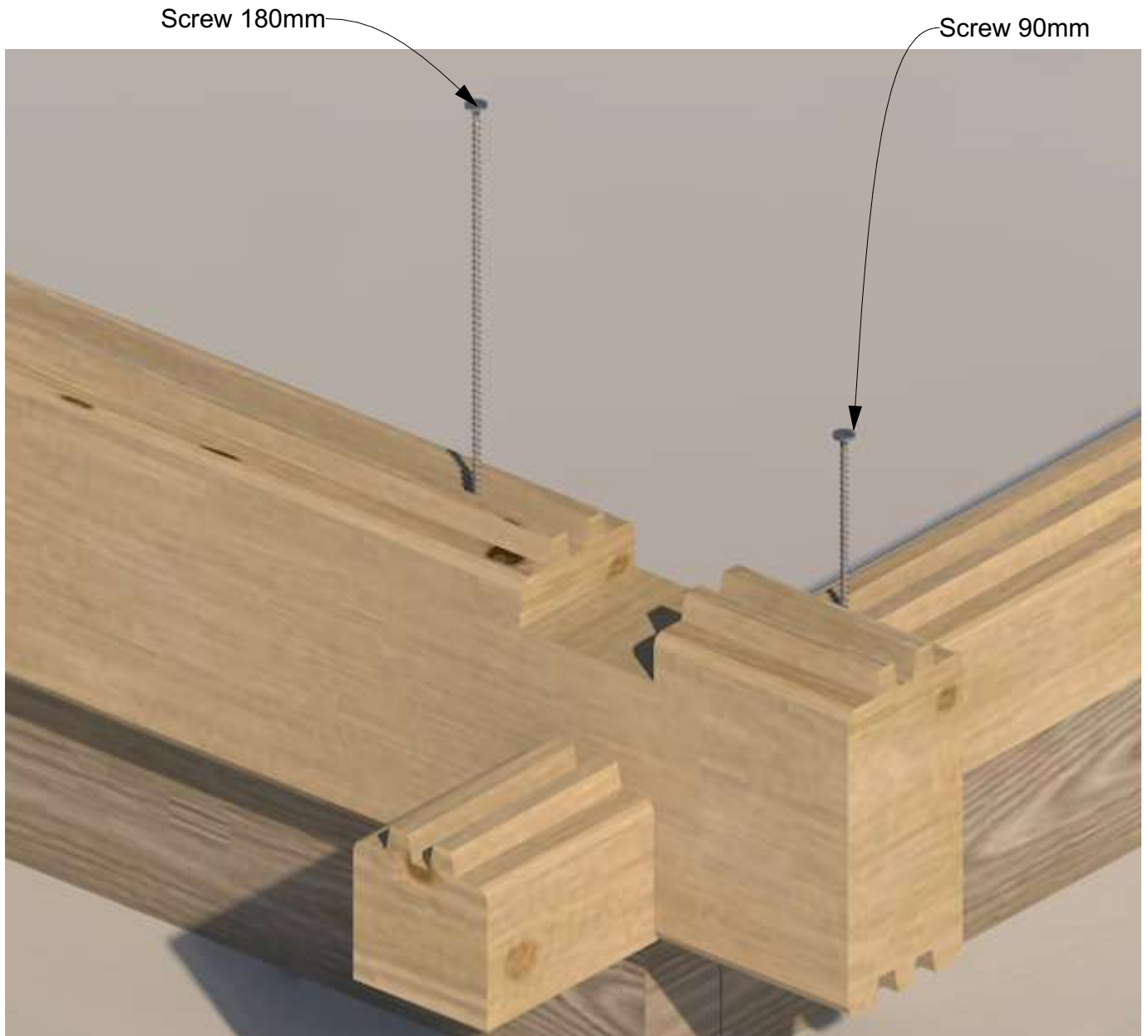

Leave 25mm gap between outer wall log and floor frame

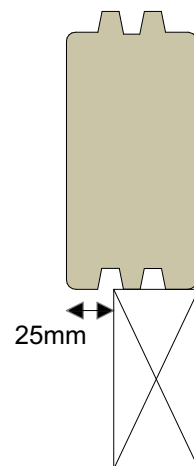

# Wall log installation

If the wall log is bent (swelling and shrinking) then use 180mm screws

Screw 180mm

Screw 180mm



To install wall logs, use hammer and hitting block

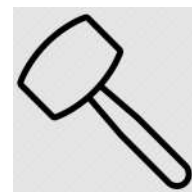

# Threaded rods

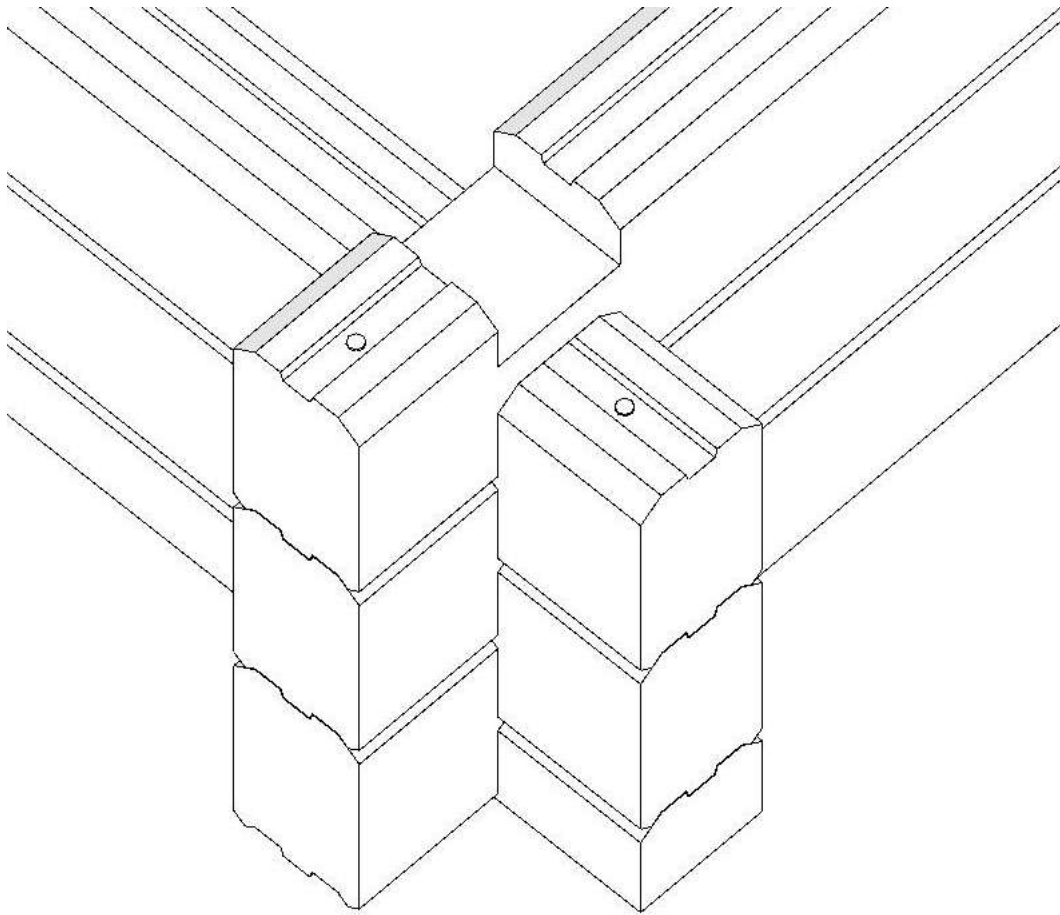

**When installing wall logs, check for threaded rod holes in every wall log. If needed, drill a new hole.**

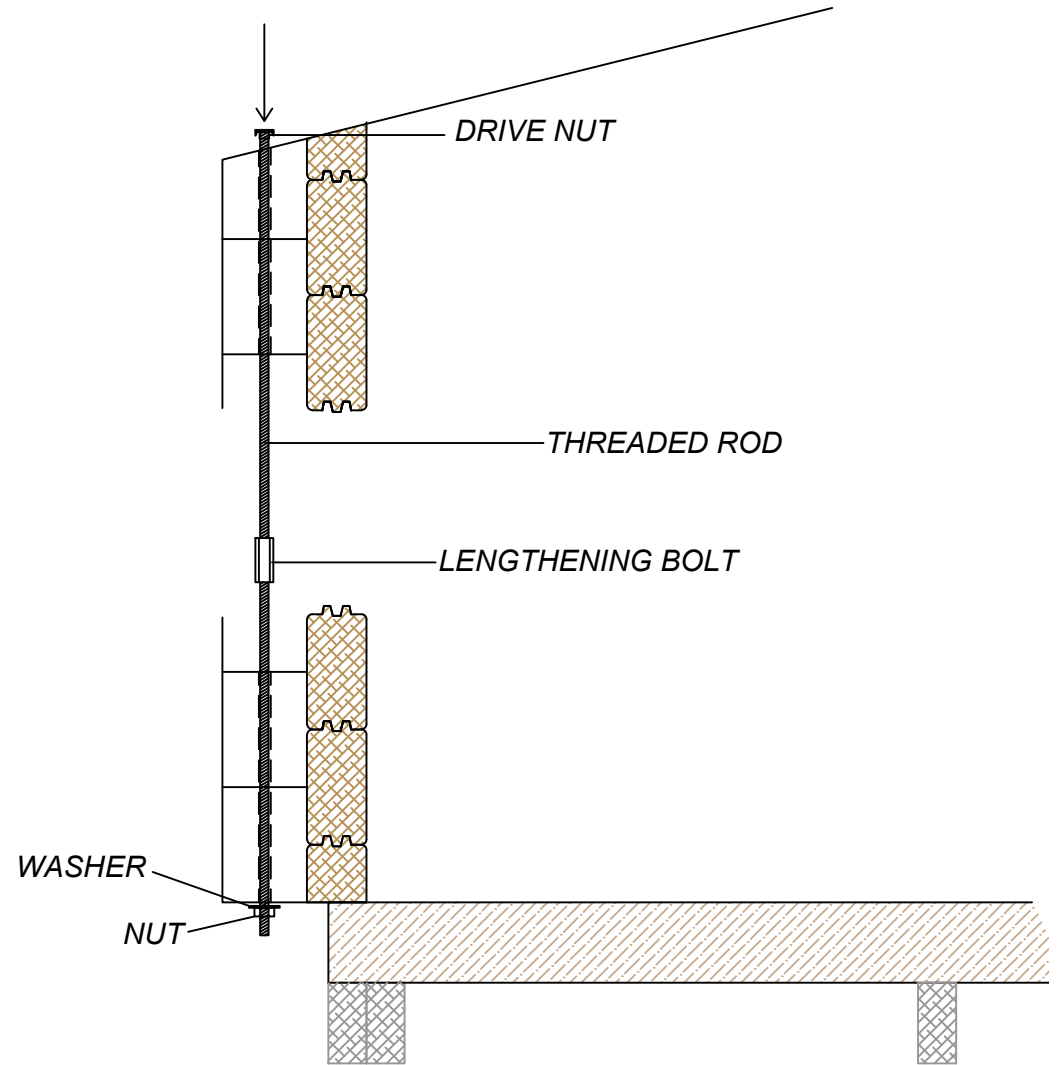

**If threaded rod is in multiple pieces, use lengthening bolt**

# Wall layouts

## Wall 1

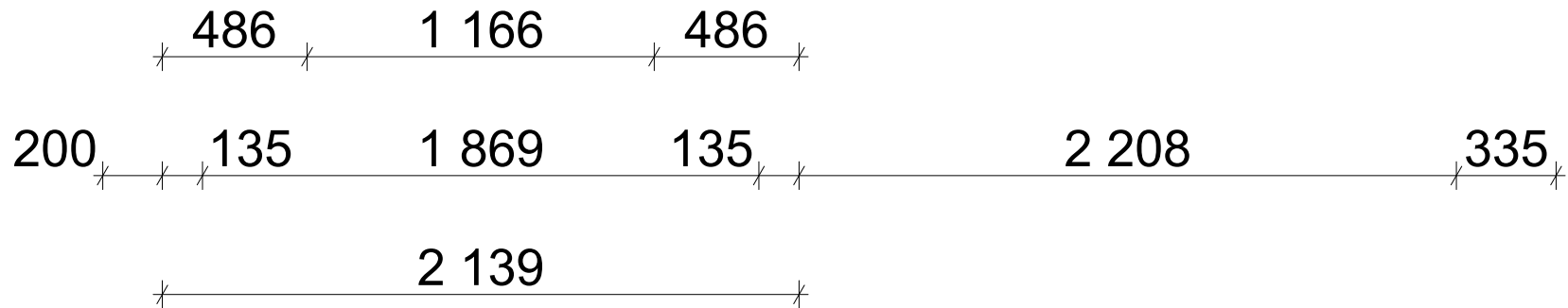
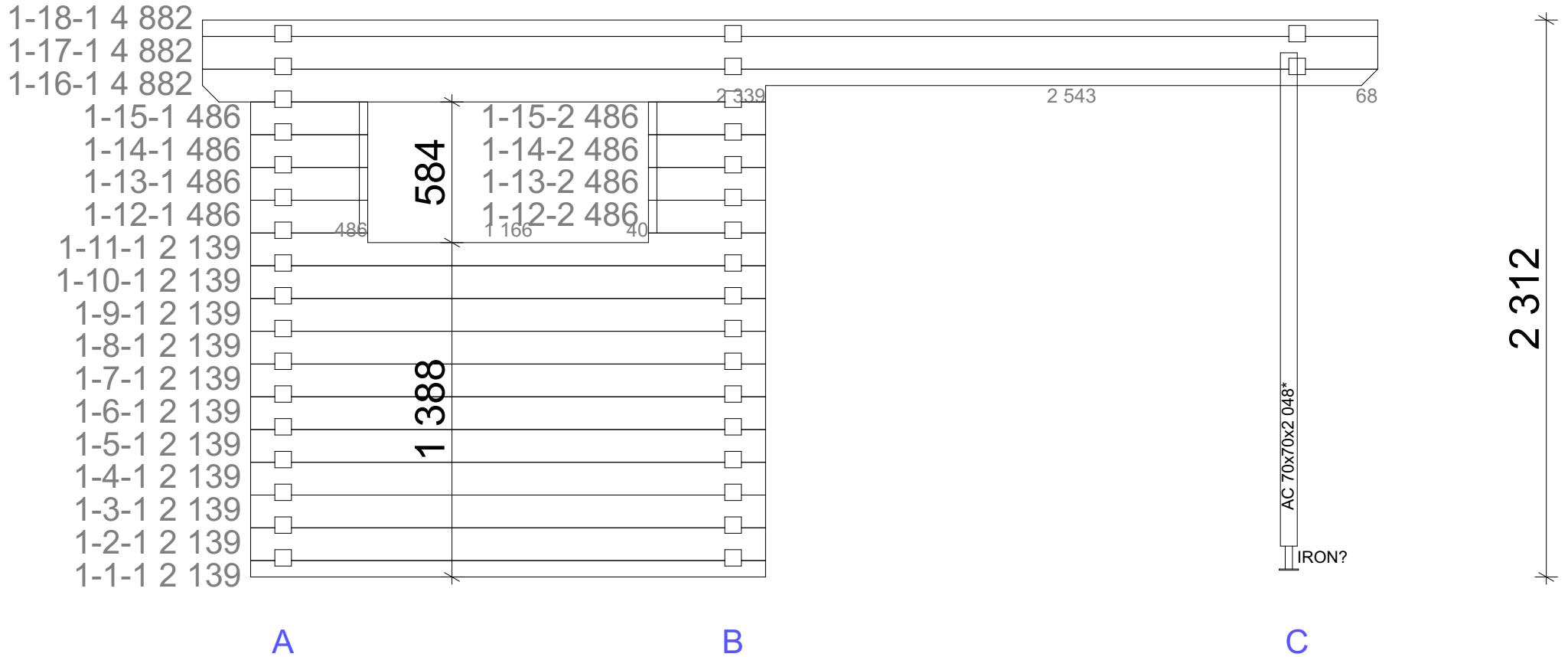



# Wall layouts

## Wall 2

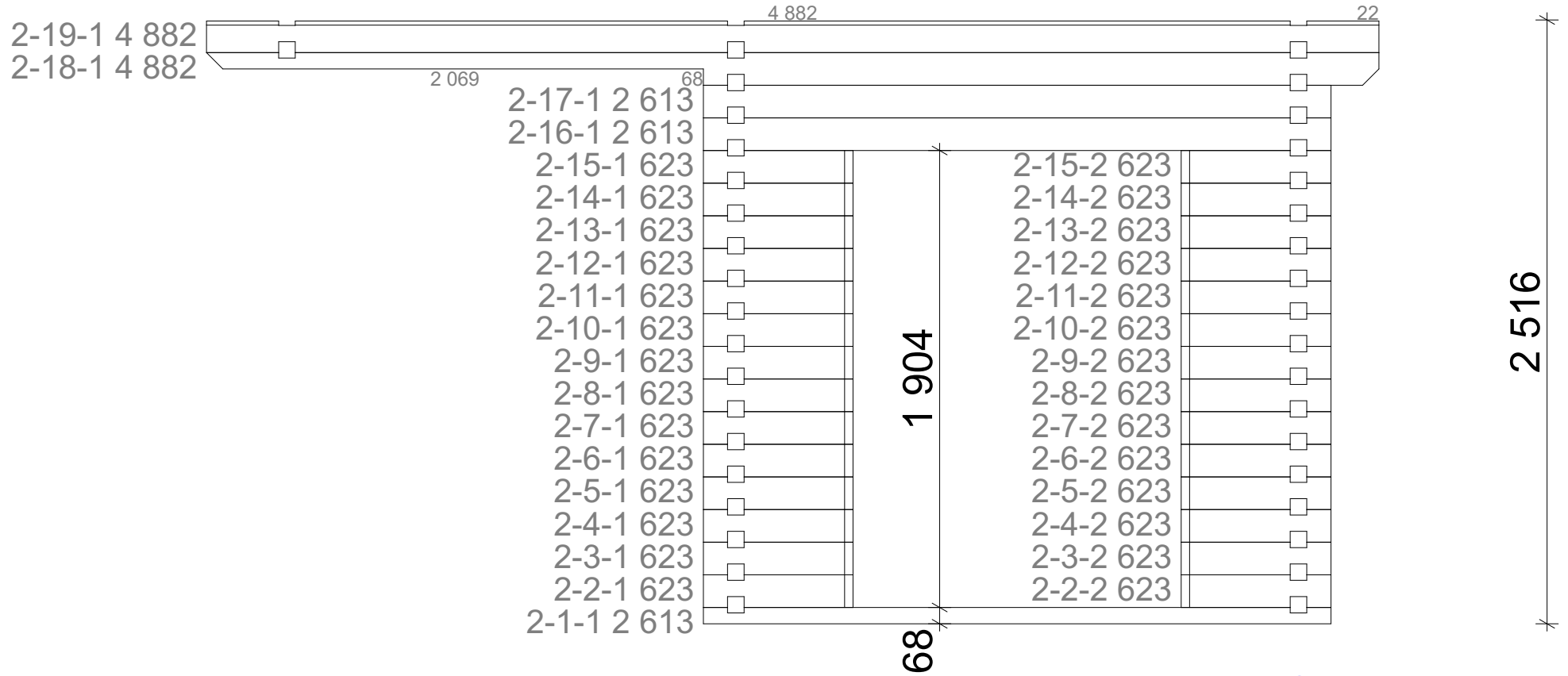

A

B

C

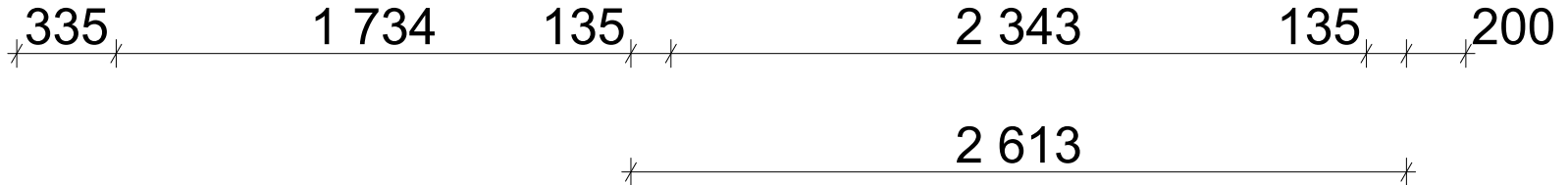

# Wall layouts

## Wall 3

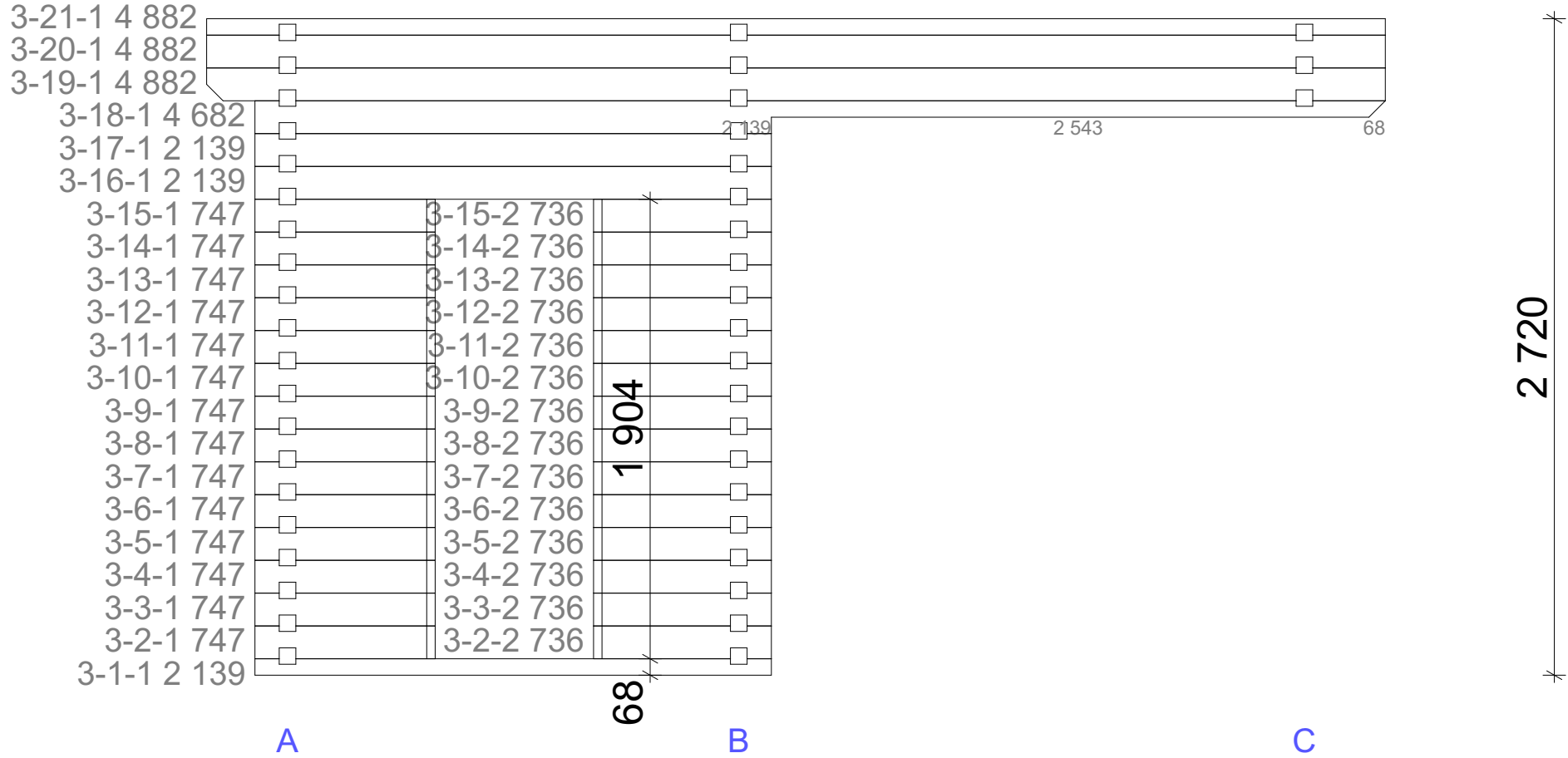

# Wall layouts

## Wall 4

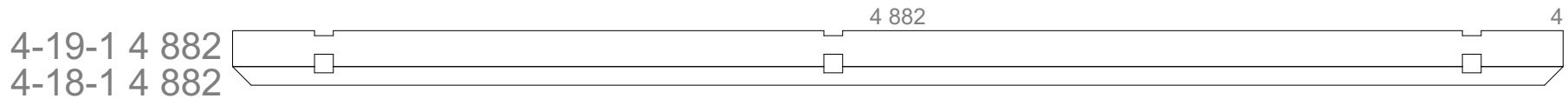

204

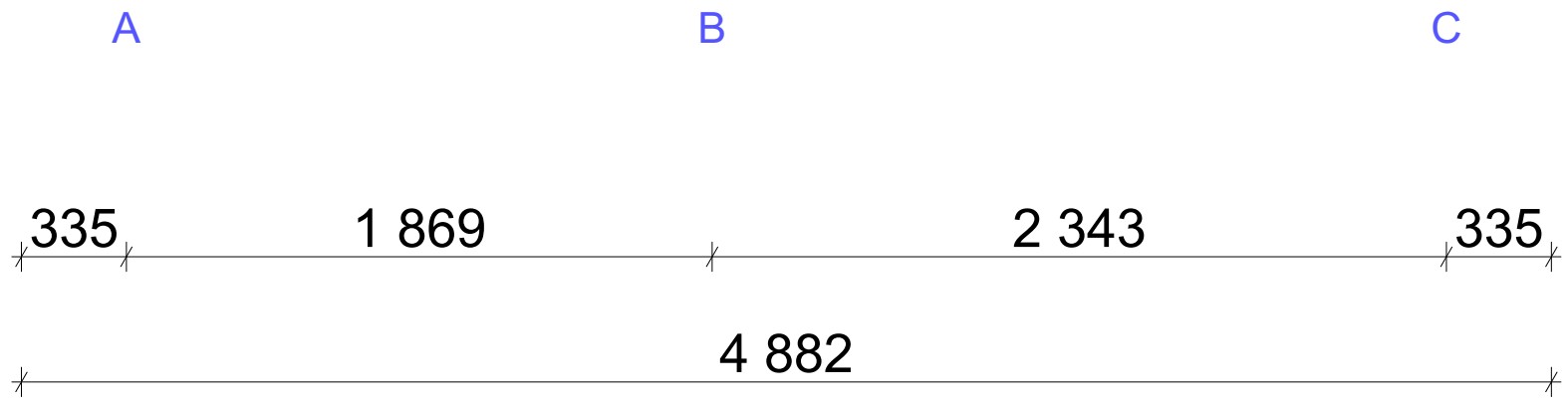

# Wall layouts

## Wall 5

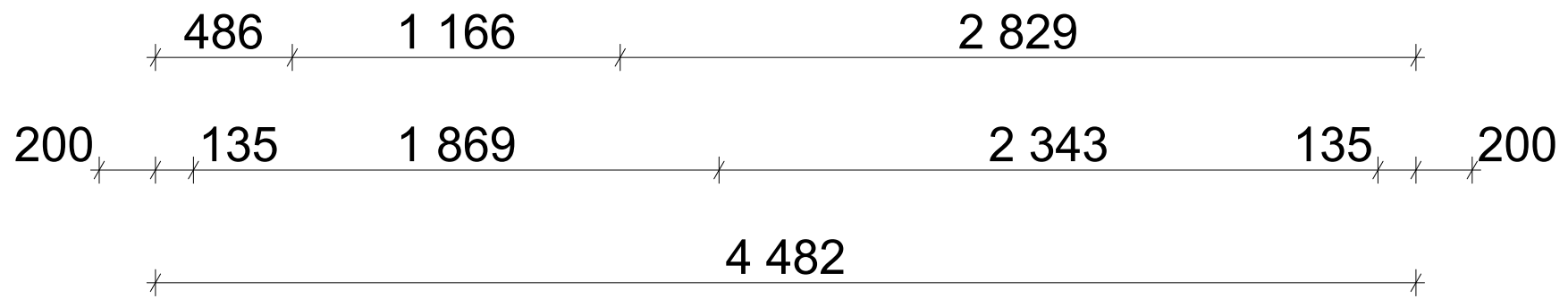
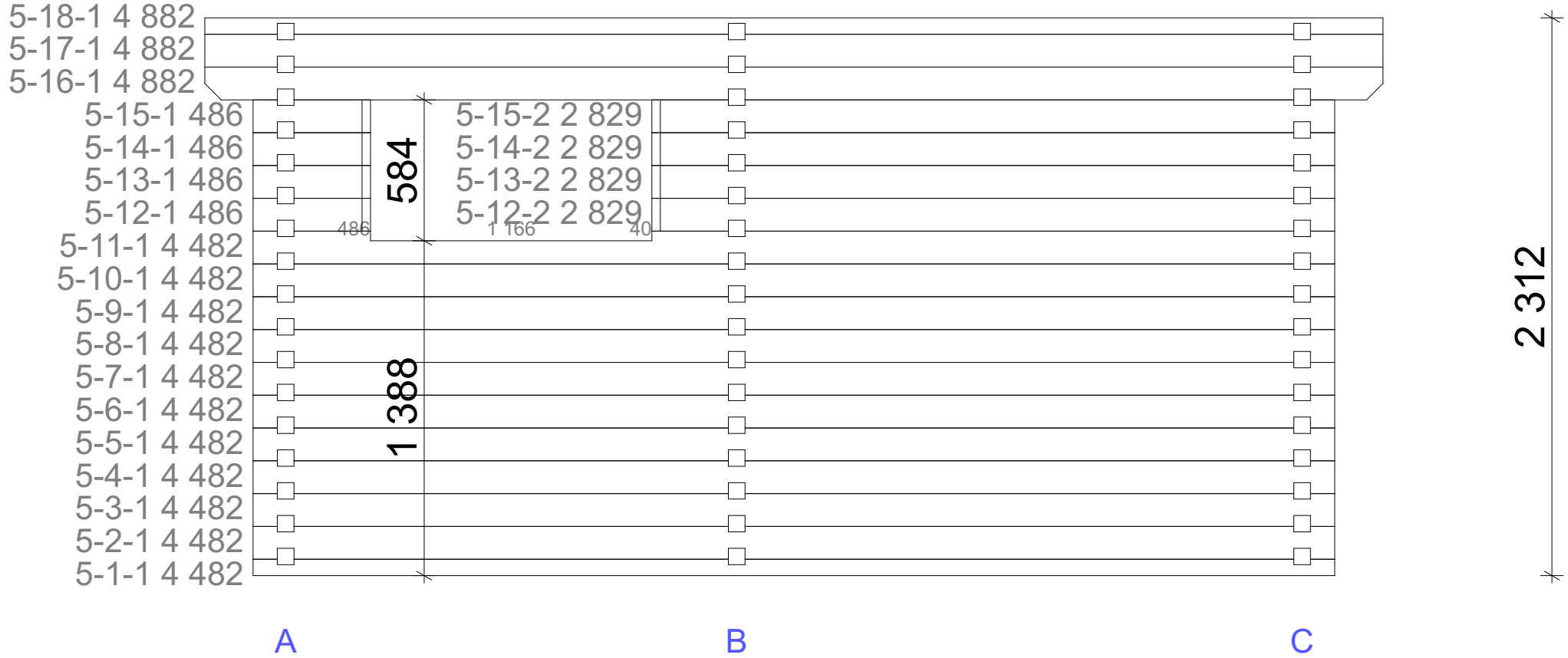

# Wall layouts

## Wall A

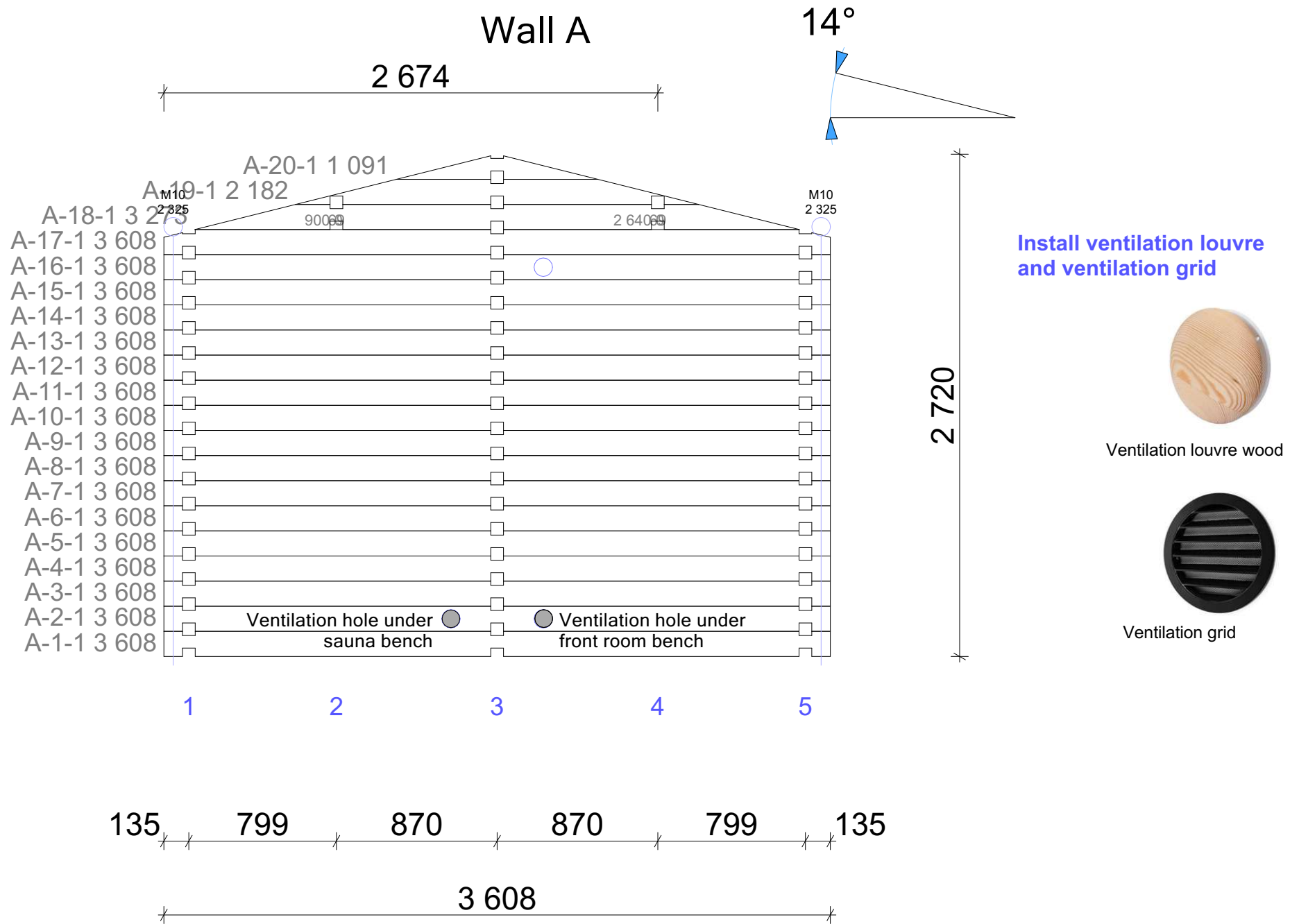

# Wall layouts

## Wall B

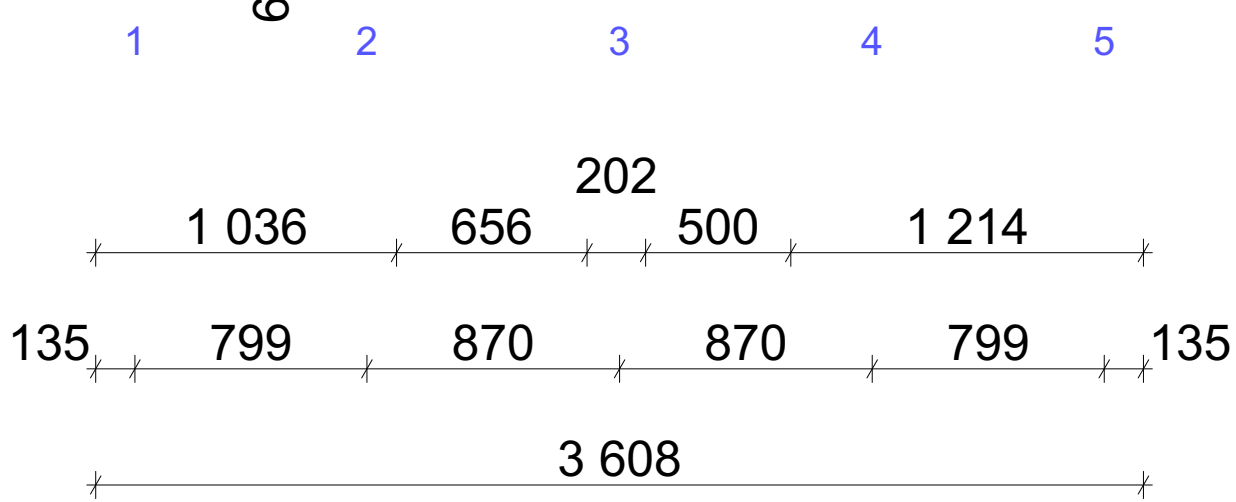
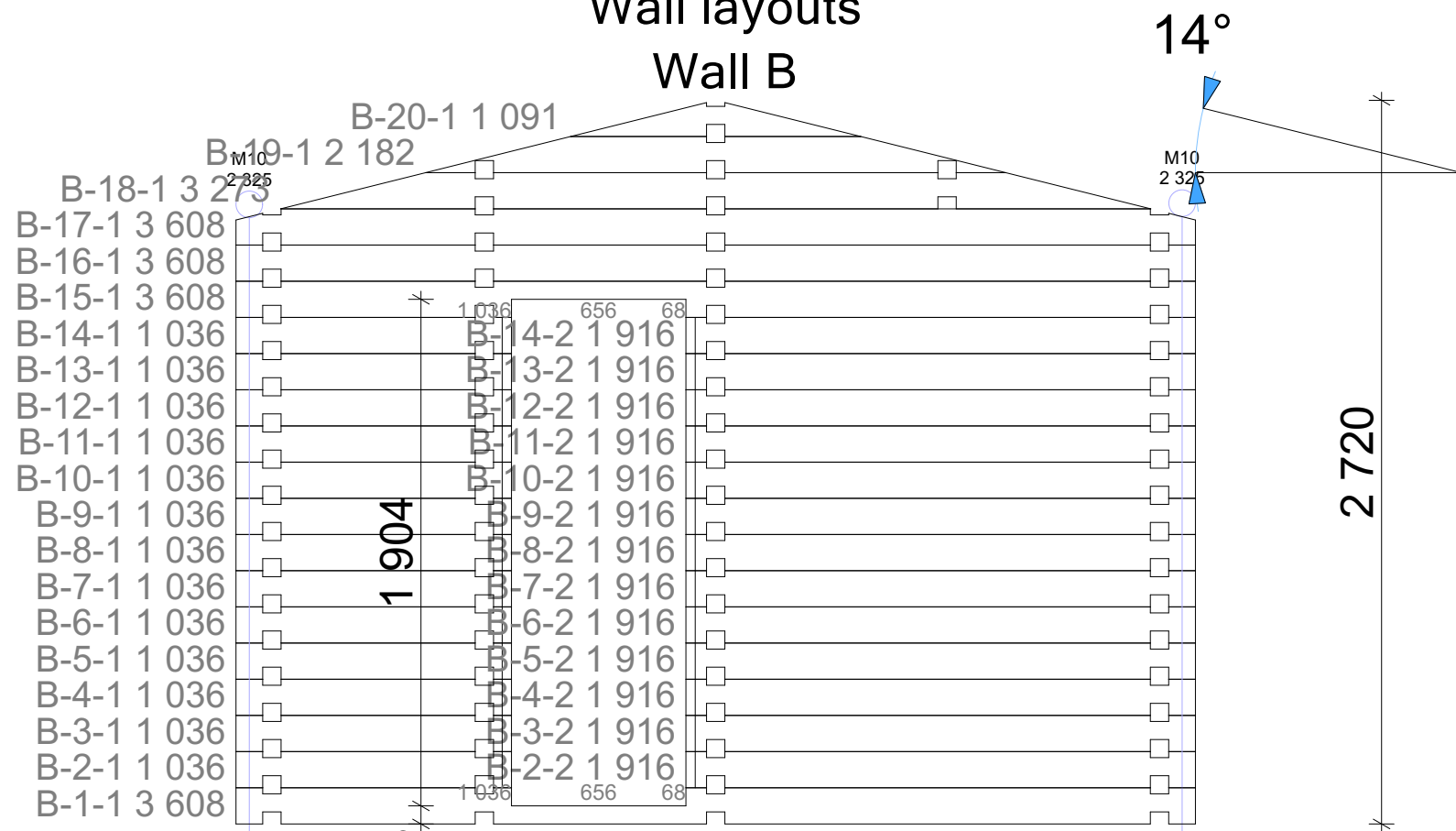

# Wall layouts

## Wall C

14°

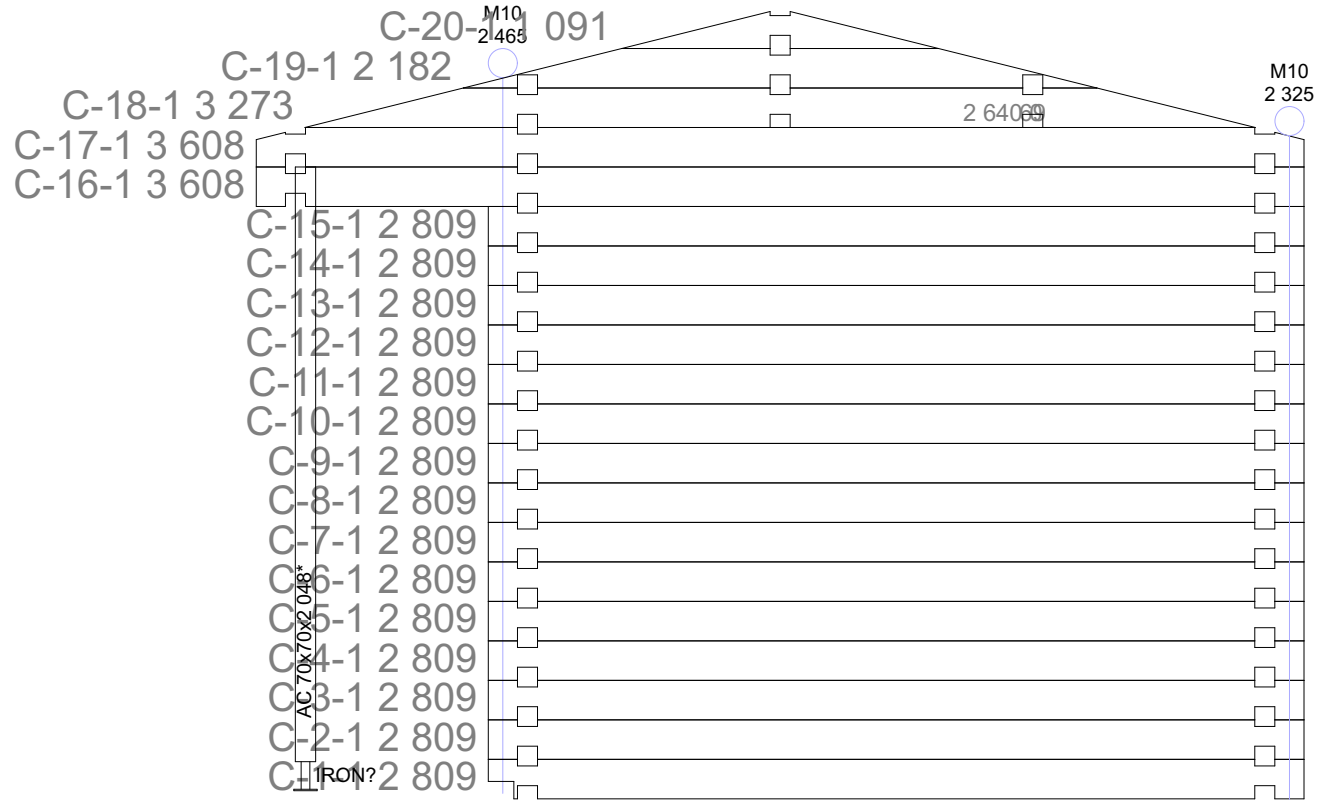
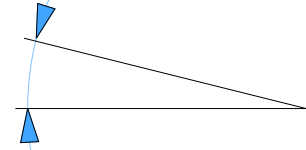

1 2 3 4 5

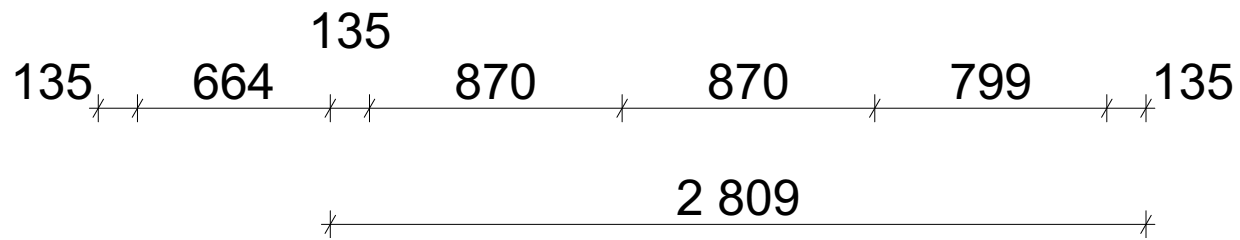

# Opening cutting

Opening upper or lower wall log vertical cut is made in site.



Horizontal cut

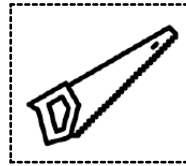

Cut in site





# Post

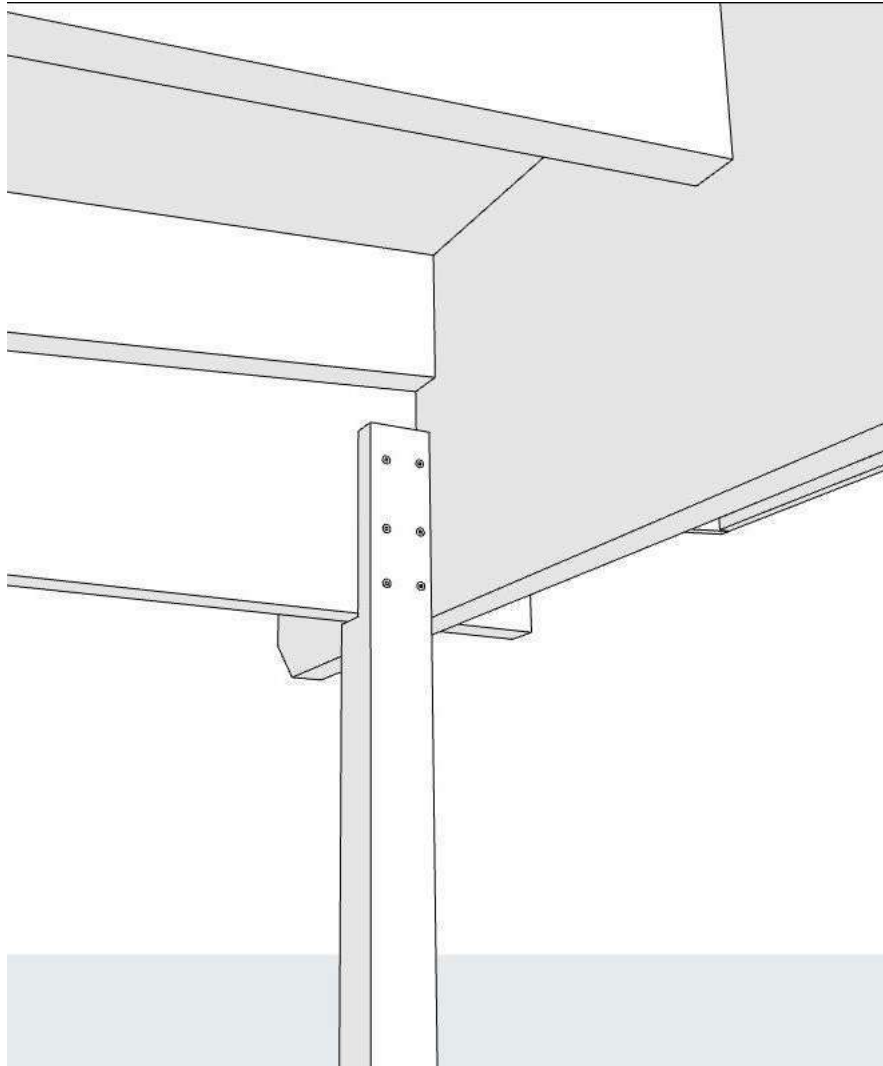

Install post to log wall with 80mm screws

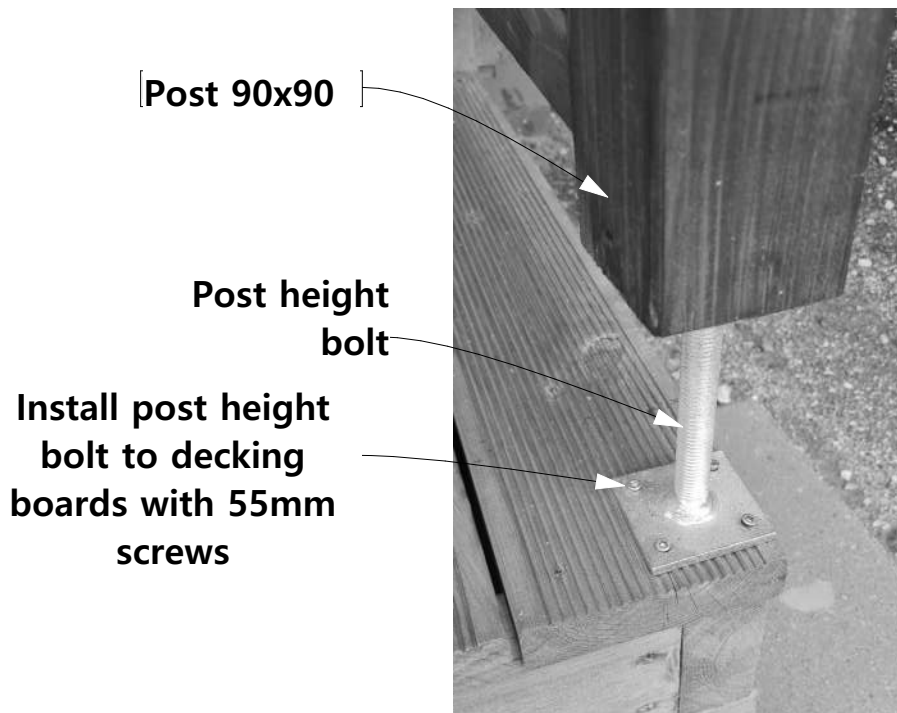

[ Post 90x90 ]

Post height  
bolt

Install post height  
bolt to decking  
boards with 55mm  
screws

# Purlins

Fix roof purlins to log walls with 180mm screws

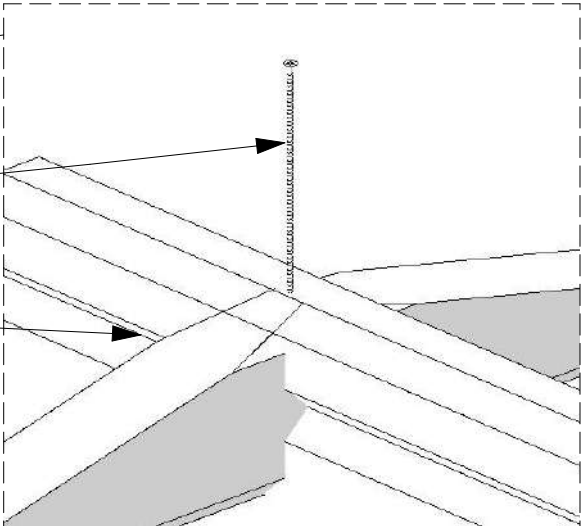
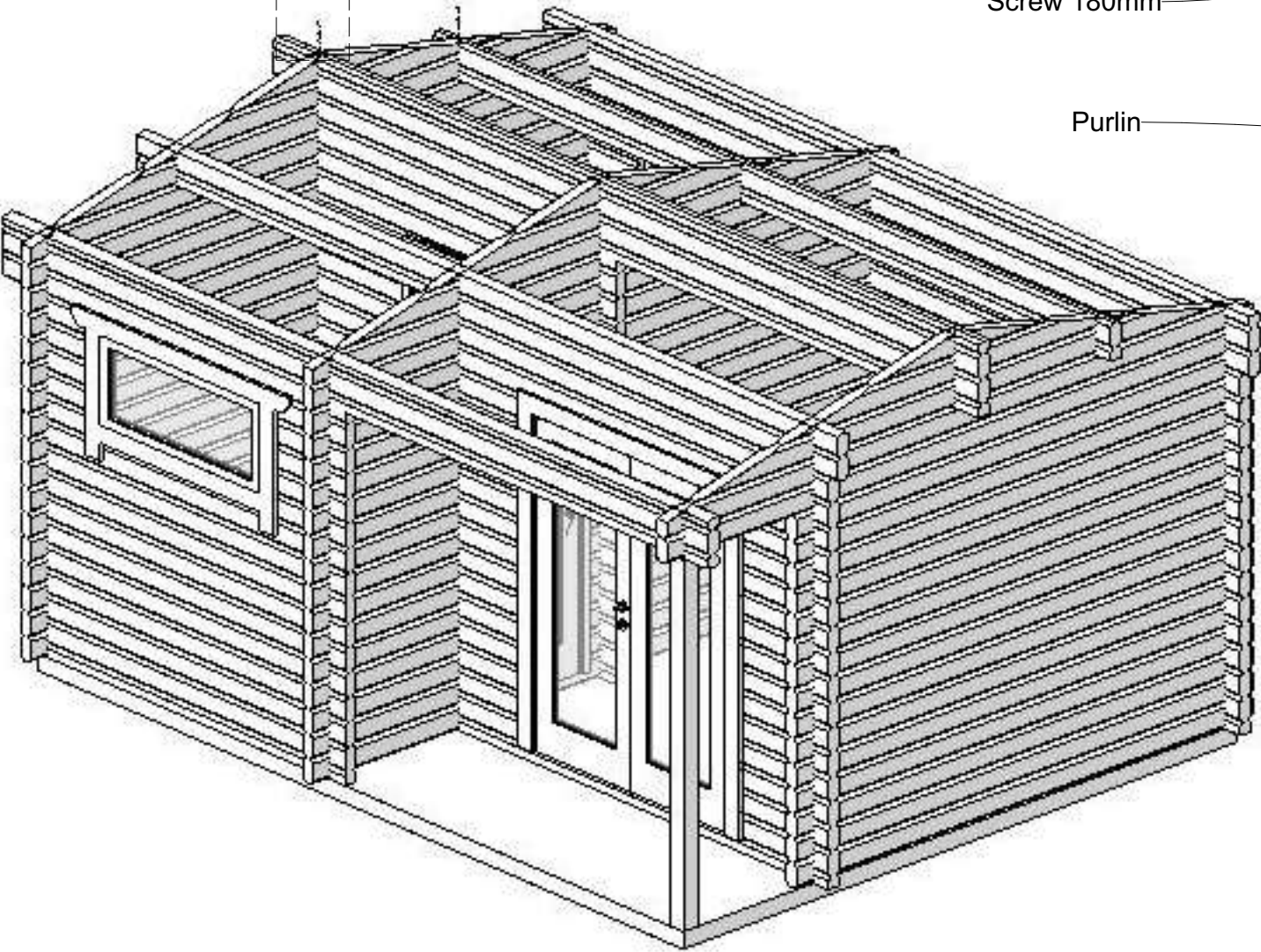

Screw 180mm

Purlin

# Roof Boards

Fix roofboards to purlins with 75mm nails.  
(2 Nails per connection)

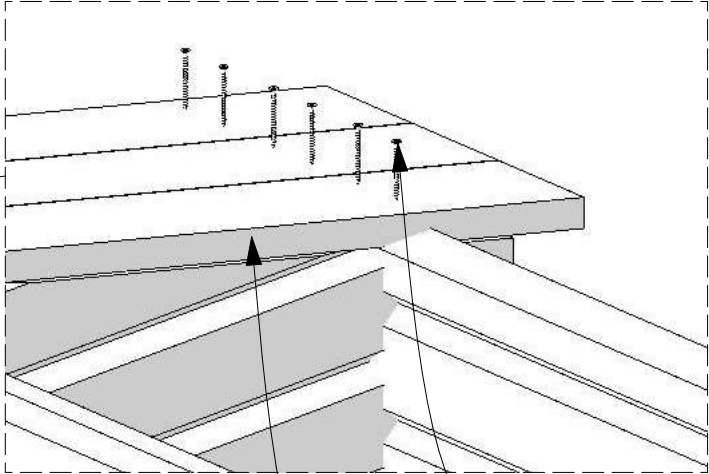
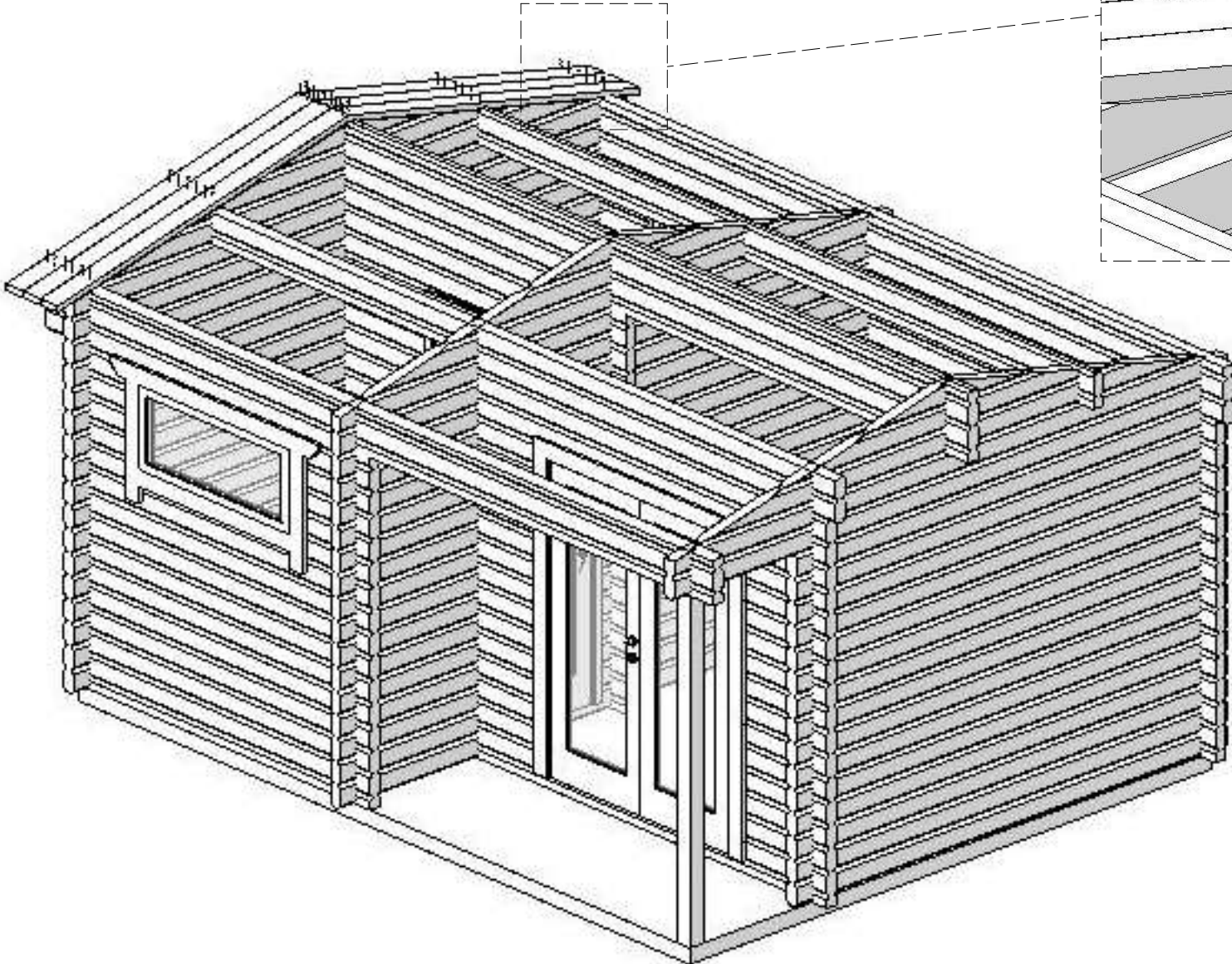

Nail 75mm  
Roof Boards

# Roof Mouldings

\*Fix roof moulding framing 45x45 to roof boards with 55mm screws.

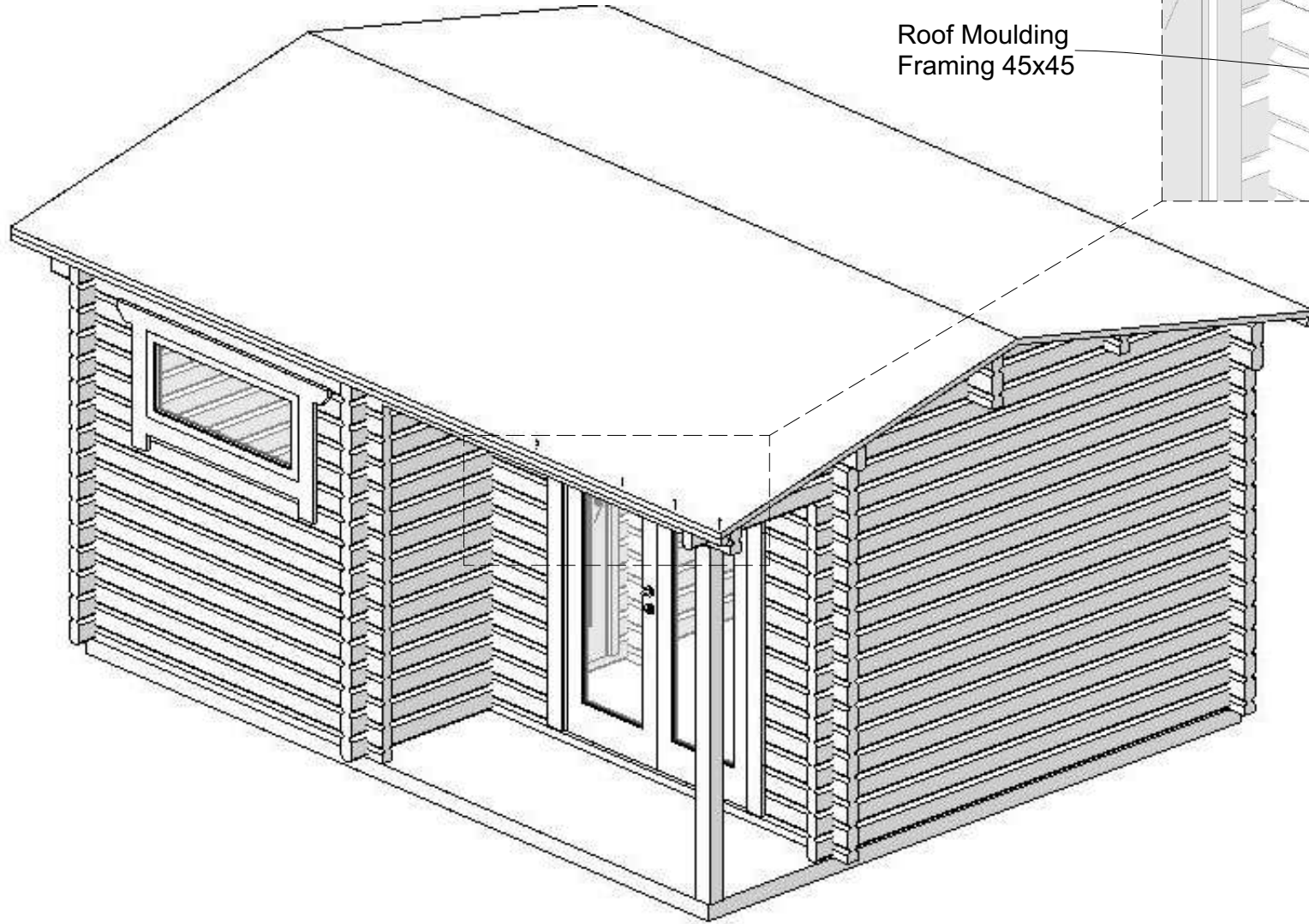

Screw 55mm

Roof Moulding Framing 45x45

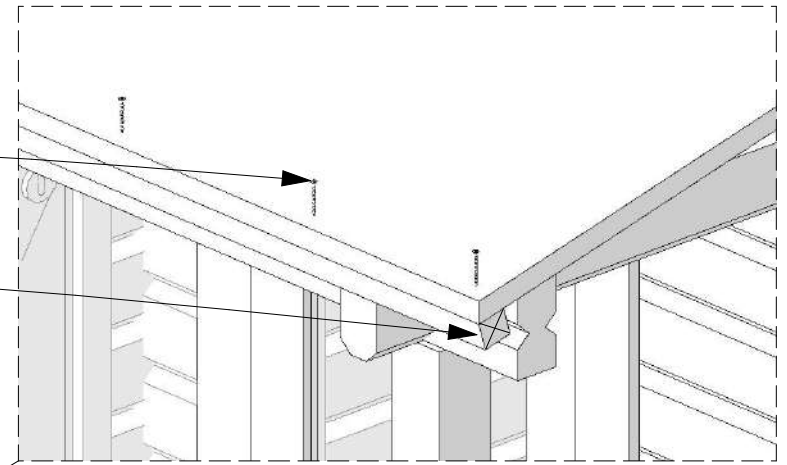

## Roof Mouldings

\*Fix roof mouldings to roof moulding framing (45x45) and purlins with 55mm screws.

Roof Moulding 18x95mm

Screw 55mm

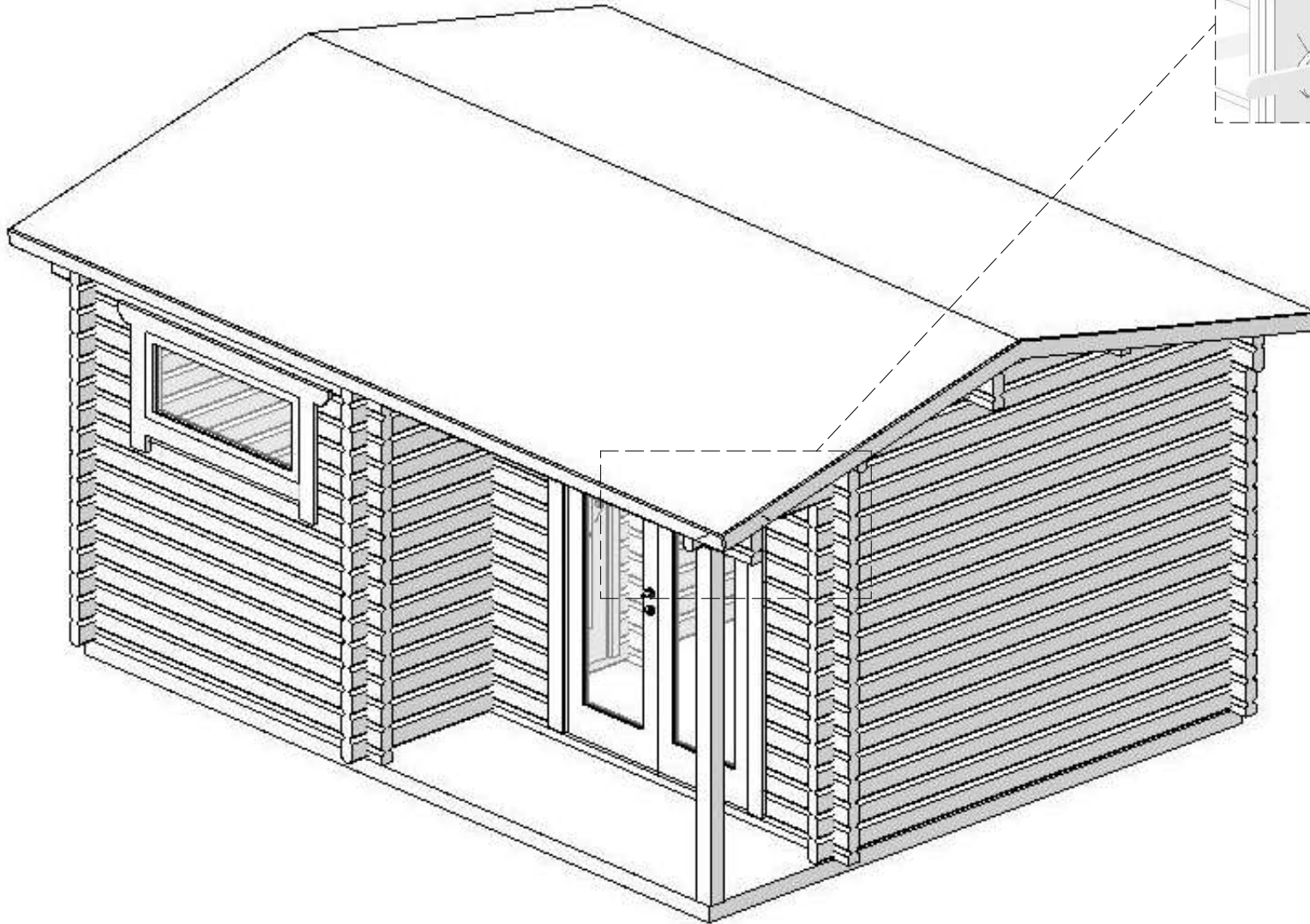
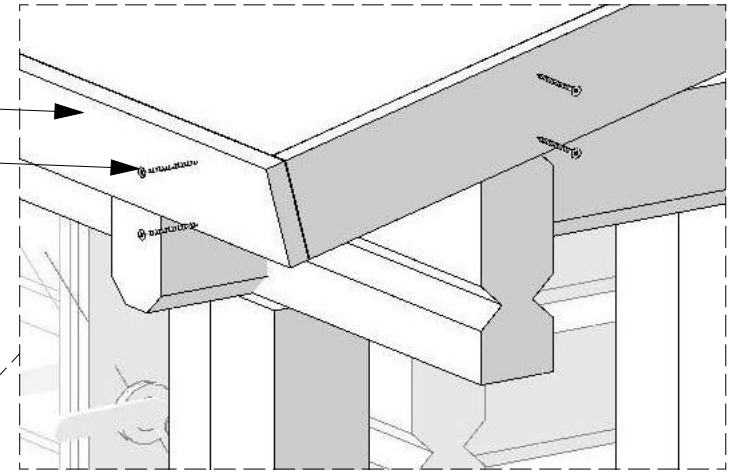

# Sauna Ceiling

Sauna ceiling  
Framing 45x45

Metal angle bracket

Top view:

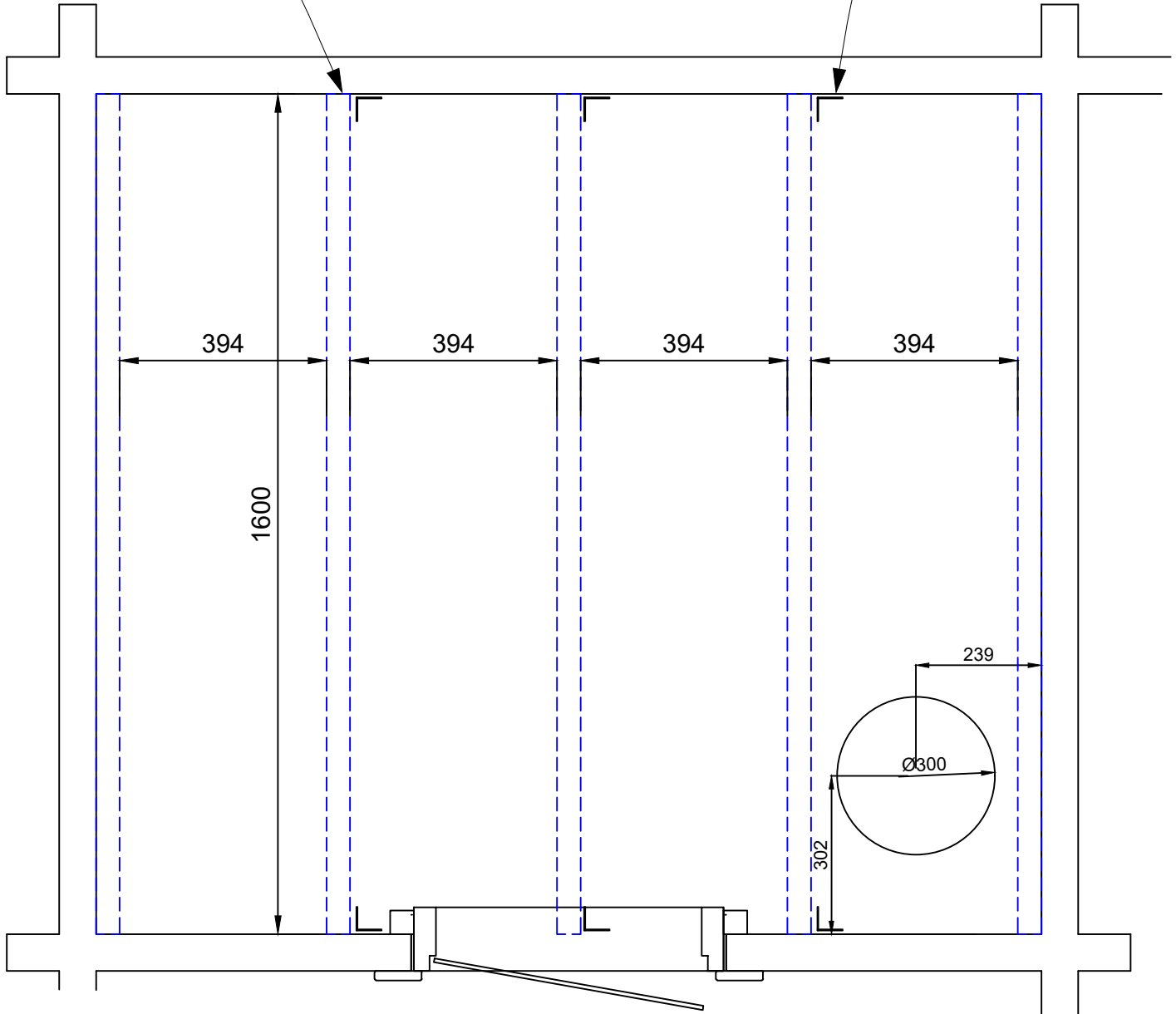

# Sauna Ceiling

Install side framing 45x45 to wall with 80mm screws.

Install middle framing to log walls with metal angle brackets and 40mm screws.

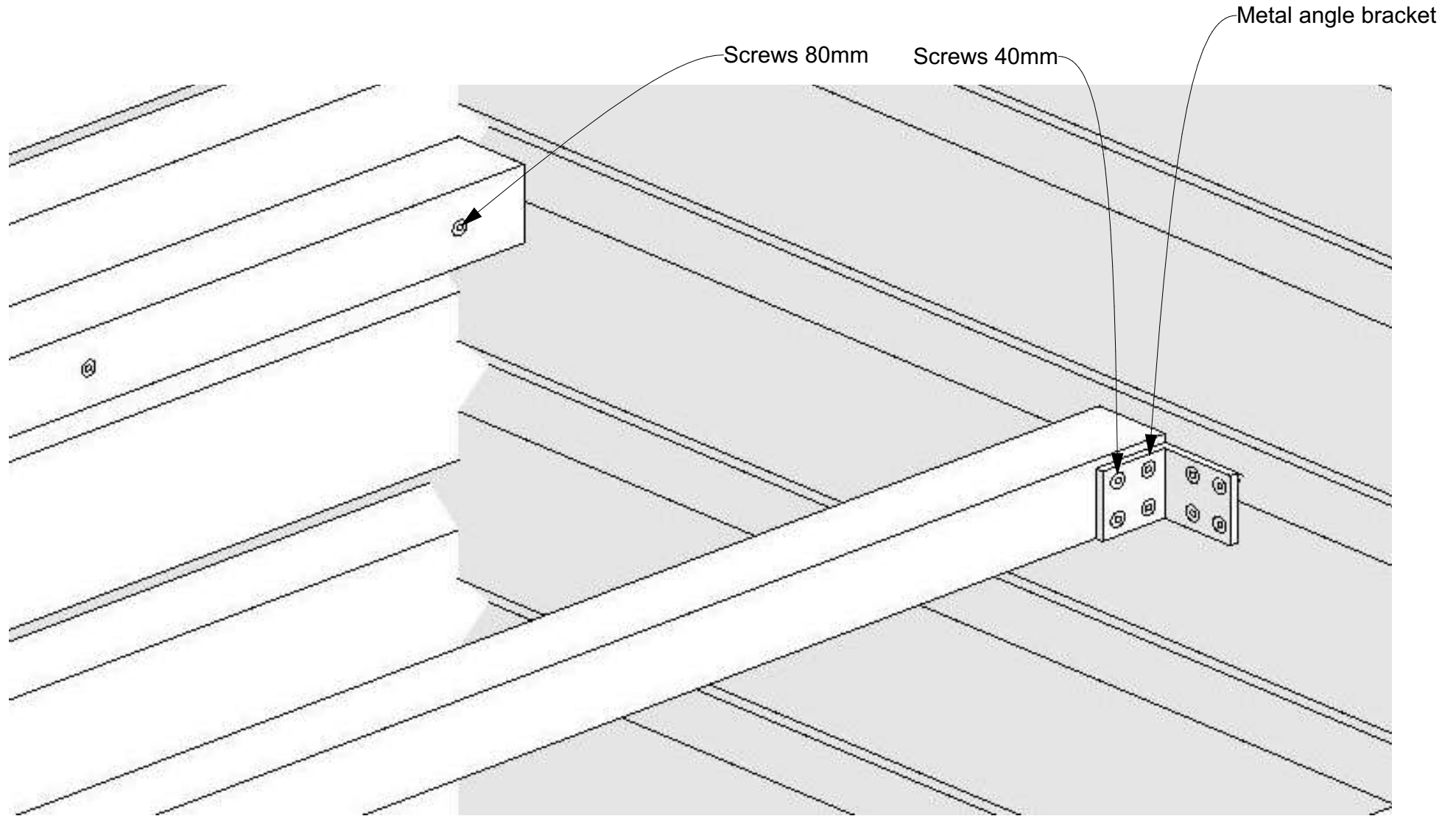

# Sauna Ceiling

Install SPU insulation with 70mm screws and distance 15x55 boards

Top view:

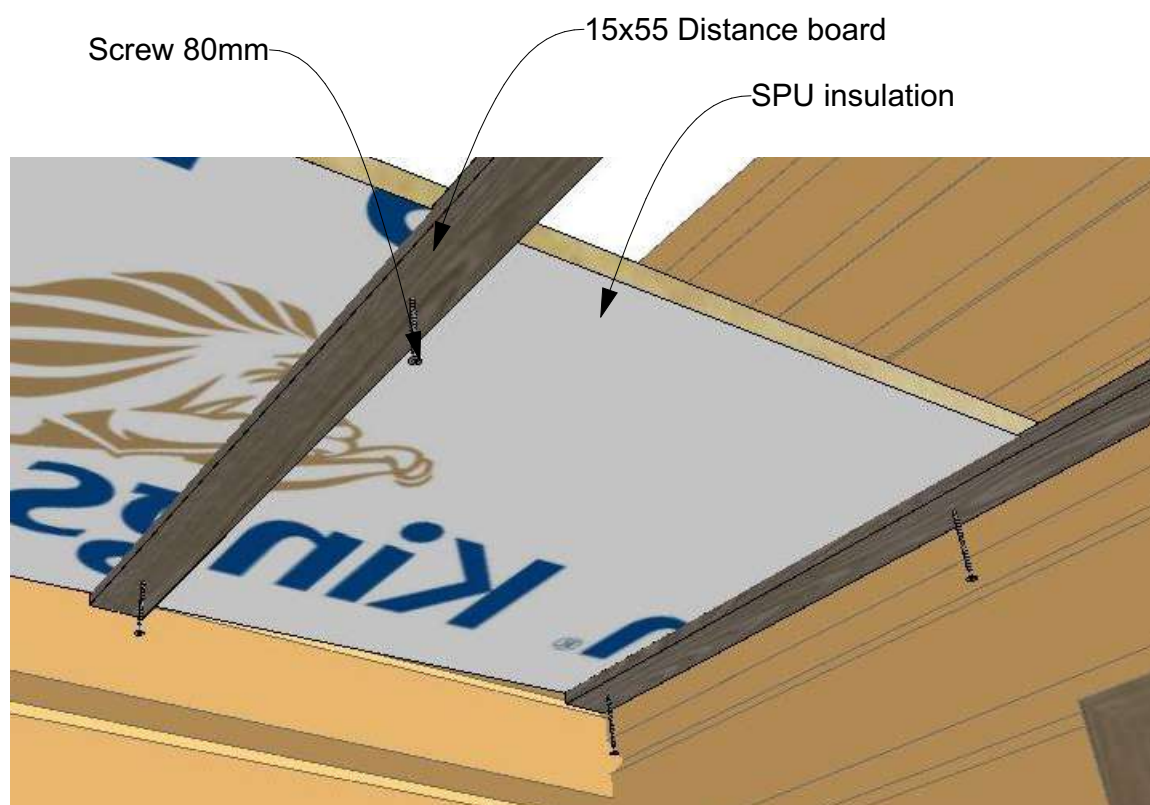
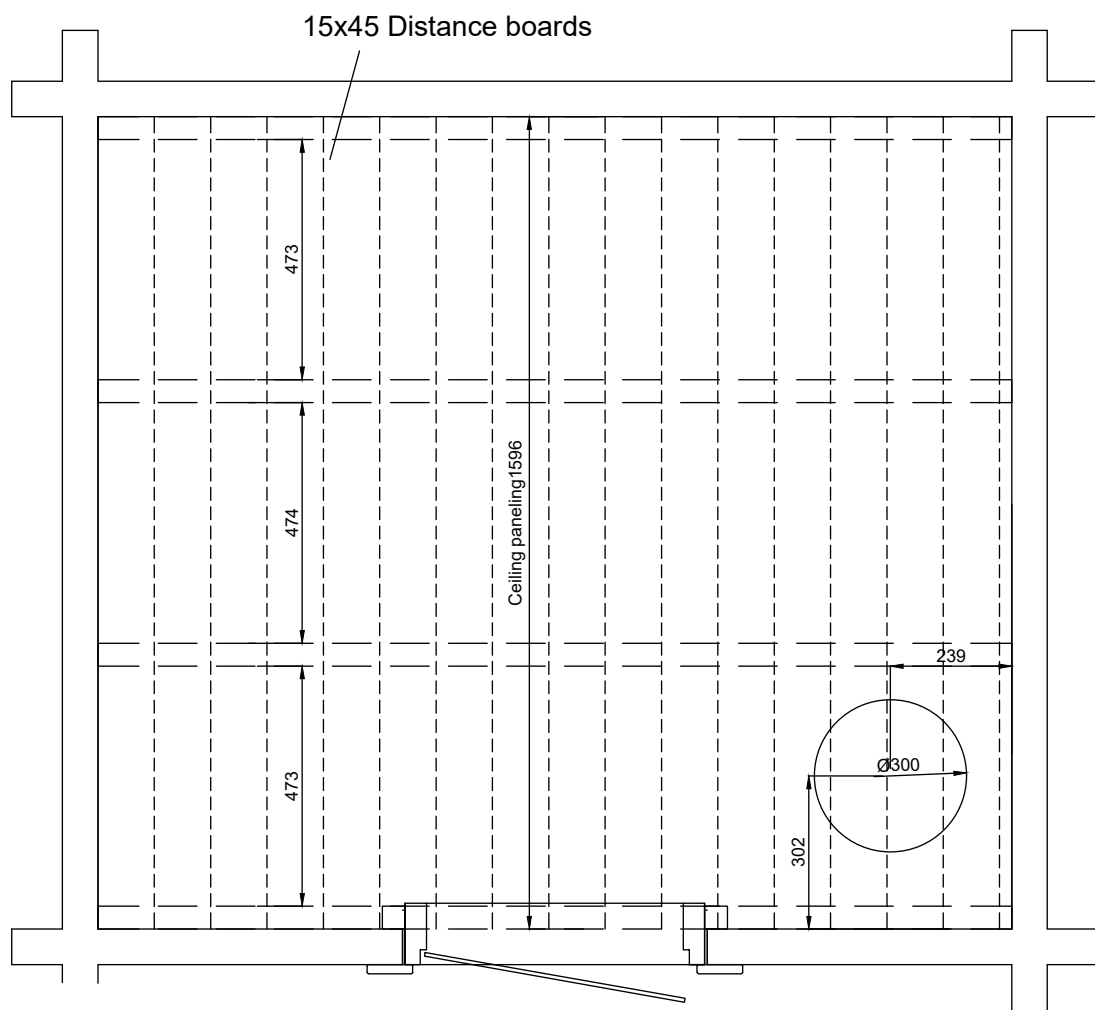

Tape SPU overlaps with foil Tape



# Sauna Ceiling

Install sauna ceiling paneling with 40mm nails

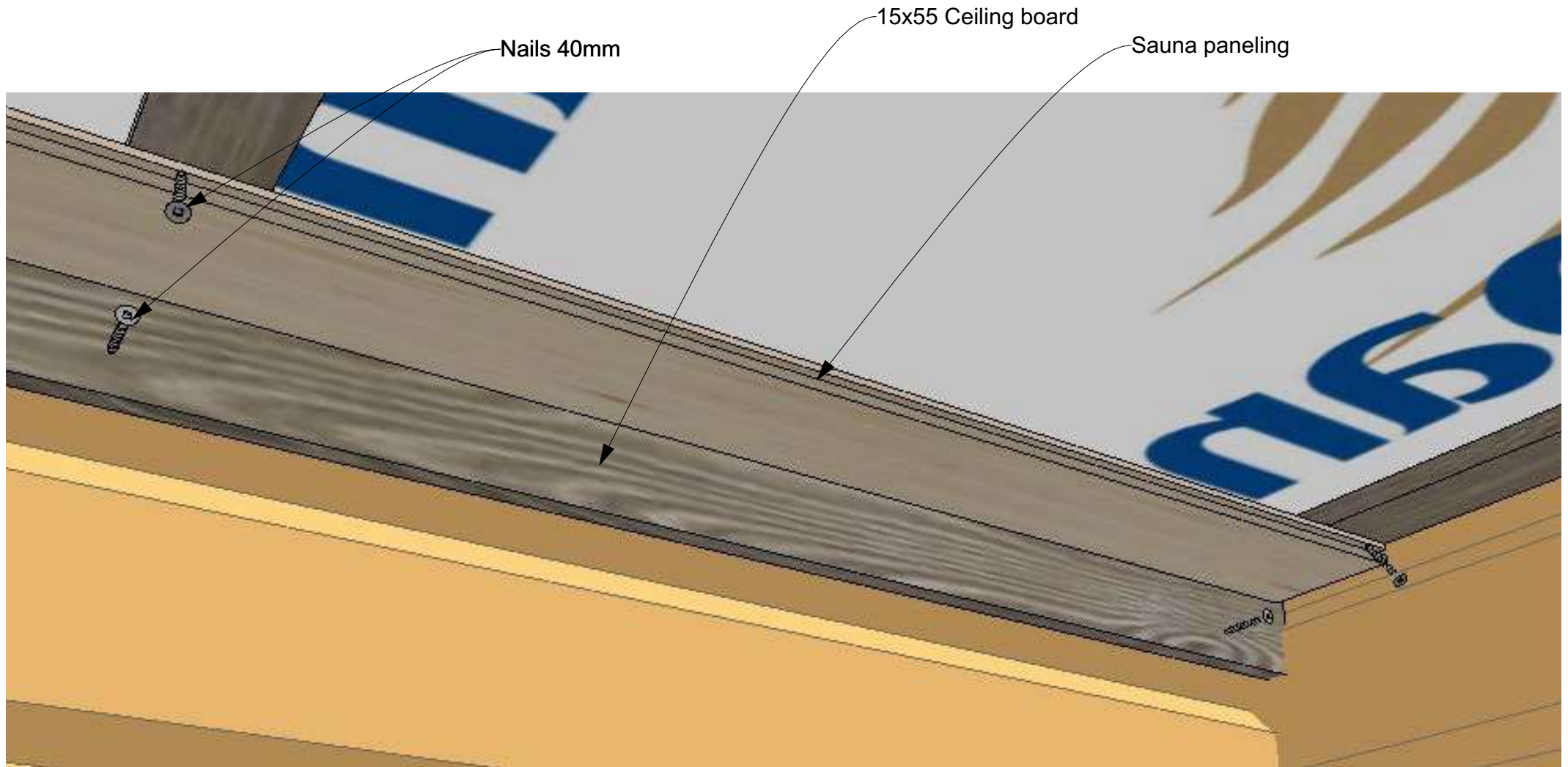

Cut the last ceiling board to length

Install 15x55 Ceiling boards with 40mm nails

## DOOR AND WINDOW

*Insert the T-shape fixing fillet to the gap in wall logs  
Fix it with the screws only in lower edge, to allow wall log movements*

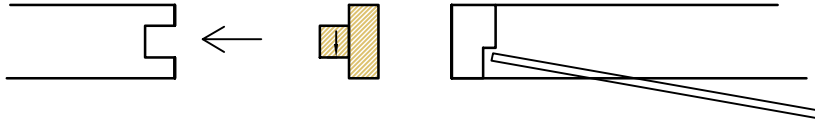

*Leave about 30-40 mm gap above the door and window  
for wall log movements.*

*If needed, fill the gap with rock wool or foam (not included)*

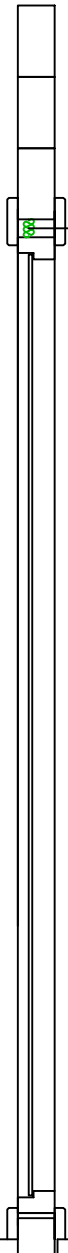

### CROSS-SECTION OF FIXING FILLET

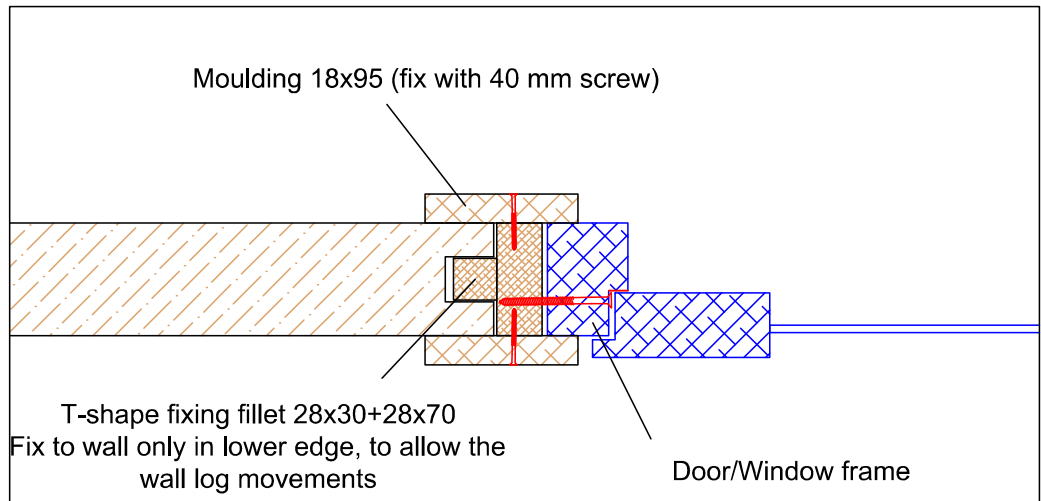

# Door and window mouldings

Install door and window mouldings with 40mm screws

## Glass door

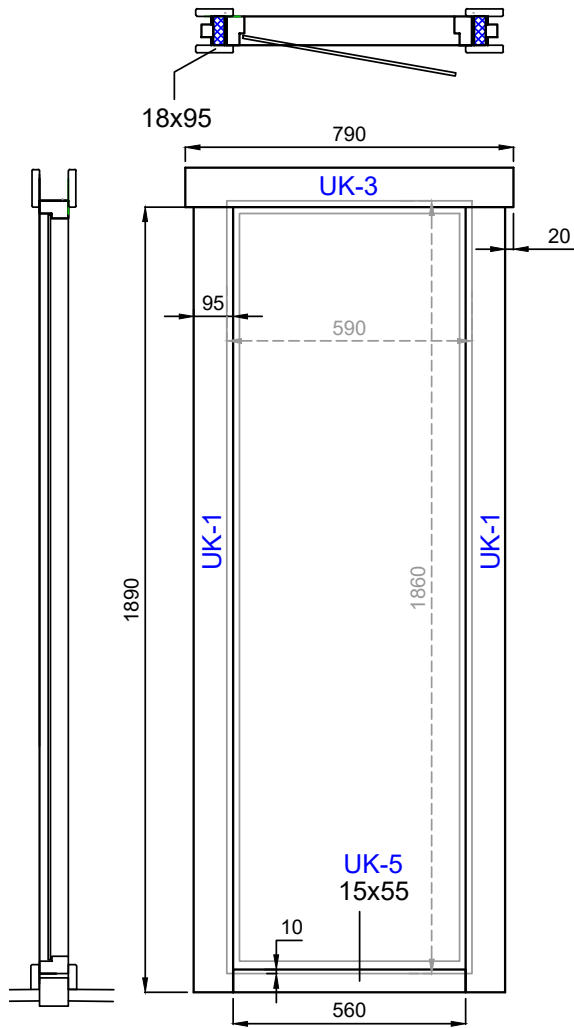

## Front door

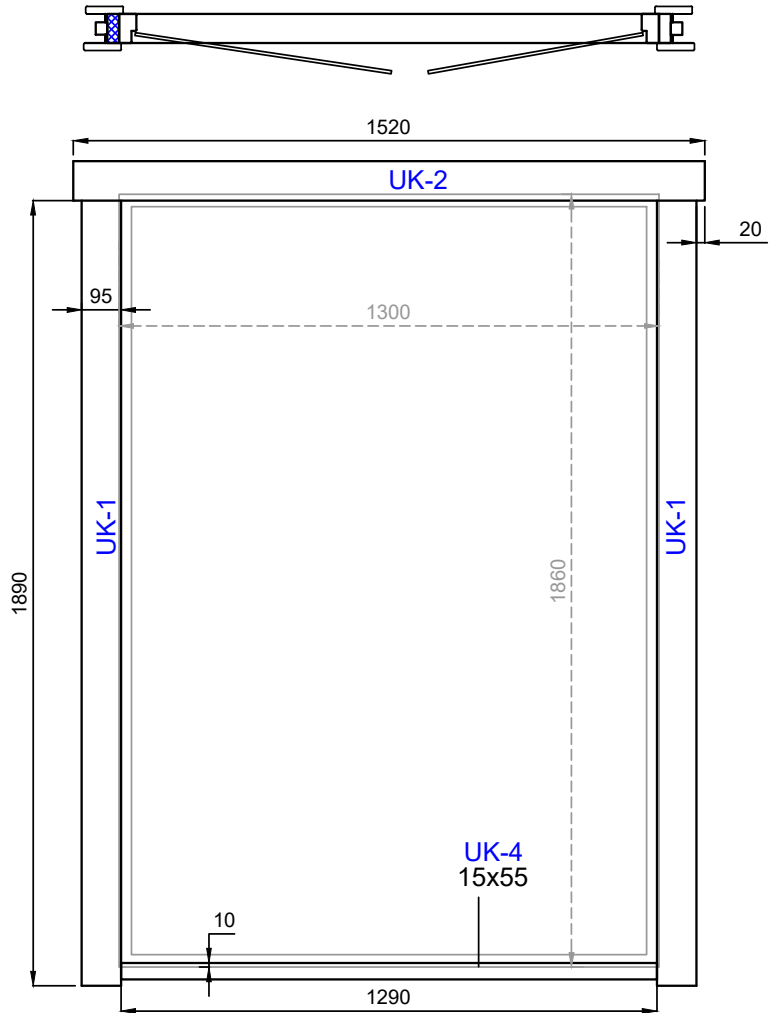

## Window

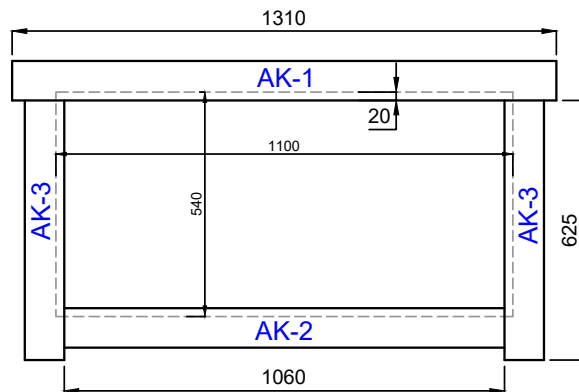

## REGULATING THE DOOR HINGES



*Remove the covers by pushing them upwards*



*FOR ADJUSTMENT LEFT/RIGHT*

*FOR ADJUSTMENT UP/DOWN*

*FOR ADJUSTMENT CLOSER/AWAY FROM FRAME*

# Sauna Benches

Install bench supports to log walls with 80mm screws

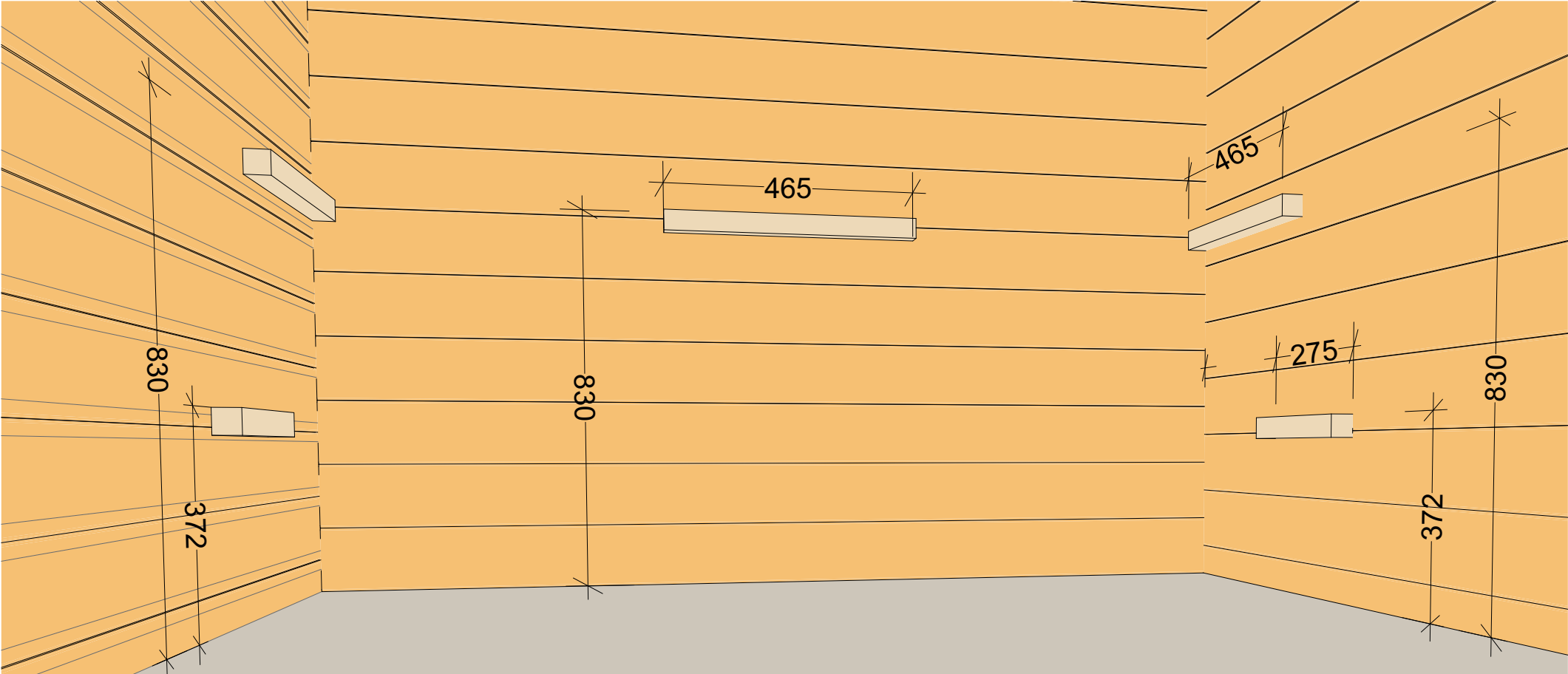

# Sauna Benches

Lift benches on top of supports  
(Functional drawing)

