

KRISTINESTAD

Installation drawings



marking			length	pcs	
	WALL LOG 70x146				
	HAMMER BLOCK 70 MM			3	
R-01	70x145 RAFTER		4706	6	
R-02	70x145 RAFTER		4706	3	
P-1	90x90 CORNER POST		2320	1	
P-2	90x90 CORNER POST		2224	1	

AR-1	45x120 FLOOR FRAME		4470	1	
AR-1B	45x120 FLOOR FRAME	<i>cutout for drainage</i>	4470	1	
AR-2	45x120 FLOOR FRAME		4023	9	
AR-3	45x120 FLOOR FRAME		3605	2	
AR-4	45x120 FLOOR FRAME		3040	8	
AR-6	45x120 FLOOR FRAME		2012	12	
AR-7	45x120 FLOOR FRAME		1800	2	
AR-8	45x120 FLOOR FRAME		457	7	
AR-5	45x95 FLOOR FRAME		2012	2	
PL-1	28x120 FLOOR BOARD (FRONT ROOM)		3555	29+3	
PL-2	28x120 FLOOR BOARD (SAUNA ROOM)		1960	18+3	
PL-3	28x120 FLOOR BOARD (WASH ROOM)		1450	18+3	
TR-1	28x120 DECKING BOARD		4500	7+1	
TR-2	28x120 DECKING BOARD		800	44+3	

VS-1	GRID WALL 600x2110			2	
------	--------------------	--	--	---	--

LI-1	UNDER THE DOOR 10x70		1580	2	

KL-1	24x120 ROOF BOARDS		4628	42+2	
KL-2	24x120 ROOF BOARDS		1670	42+2	
SL-2	14x121 CEILING BOARD FOR SAUNA ROOM		1996	18+2	
SR-3	45x45 CEILING BOARD SUPPORT		1996	2	
RL-2	45x45 ROOF EDGE BOARD SUPPORT DETAIL		330	10	
SL-2	15x55 CEILING DISTANCE BOARD		1995	5	
PP-1	15x55 FLOOR AND CEILING MOULDINGS		~4800	24	
RL-1	18x95 ROOF EDGE BOARD		~4800	24	
ST-1	45x171 ABOVE THE ROOF (SIDES)		4700	2	
	TRIANGLE PROFILE FOR ROOF EDGES (UNDER SBS)		~4 m	2	

A-1	WINDOW 70x1100x1729 + MOULDINGS			3	
U-1	DOOR 70x1580x2000 + MOULDINGS			2	
U-2	GLASS DOOR 70x690x1980 BRONZE + MOULDINGS			2	







TE-1	25x25 + 28x70 "T" FIXING FILLET		2000	4	
TE-2	25x25 + 28x70 "T" FIXING FILLET		1980	4	
TE-3	25x25 + 28x70 "T" FIXING FILLET		1729	6	

	BENCH MODULE 600x1992			1	
	BENCH MODULE 400x1992			1	
	BENCH MODULE 300x1992			1	
	BENCH MODULE 500x1397			1	
	BENCH MODULE 300x1068			1	
	BENCH SKIRT 1992			1	
	BENCH SKIRT 1447			1	
	BENCH SUPPORTS			1	
	VERTICAL BENCH SUPPORT 45x45		1000	1	
VS-1	GRID WALL 600x2060			2	

	SLOPE DETAIL UNDER FLOOR BOARD 3 MM		1995	2	
	SLOPE DETAIL UNDER FLOOR BOARD 6 MM		1995	2	
	SLOPE DETAIL UNDER FLOOR BOARD 9 MM		1995	2	
	SLOPE DETAIL UNDER FLOOR BOARD 12 MM		1995	1	

RN-1	WATER DRAINAGE GUTTER	LEFT		1	
RN-2	WATER DRAINAGE GUTTER	RIGHT		1	

	SPU CEILING INSULATION 30x600x1200	SAUNA ROOM		6	
	ALUMINIUM PROFILE FOR DOOR/FLOOR MOULDING			2	

	TREADED ROD M10		2580	3	
	TREADED ROD M10		2520	3	
	LENGTHENING BOLT M10			6	
	DRIVE NUT FOR TREADED ROD			6	
	PLAIN WASHER FOR TREADED ROD			6	
	NUT FOR TREADED ROD			6	
	SLIDING BRACKET 35x35x130 FOR GRID WALL			6	
	WASHER M5 FOR GRID WALL			6	
	L-BRACKET 40x40x40 FOR ROOF EDGES			10	
	BEAM BRACKET 45x97 FOR FLOOR FRAME			10	
	POST HEIGHT ADJUSTMENT			2	
	SCREW 3,5x40 FOR MOULDINGS			400	
	SCREW 5x90 FOR FLOOR FRAME			300	
	SCREW 4,2x55 FOR FLOOR BOARDS			600	
	SCREW 4,2x55 FOR DECKING BOARDS			600	
	SCREW 4,5x80 FOR BENCH SUPPORTS, POST,			100	
	SCREW 6x180 FOR RAFTERS AND WALL CONNECTIONS			300	
	SCREW 5x40 FOR METAL BRACKETS			100	
	NAIL 75 MM FOR ROOF BOARDS			~500	
	NAIL 40 MM FOR CEILING BOARDS			~1000	
	VENTILATION LOUVER D100 WOOD			3	
	VENTILATION GRID D100 METAL			3	
	FOIL TAPE			1	
	FLEX FOAM FOR WINDOWS AND DOORS			1	

TOP VIEW

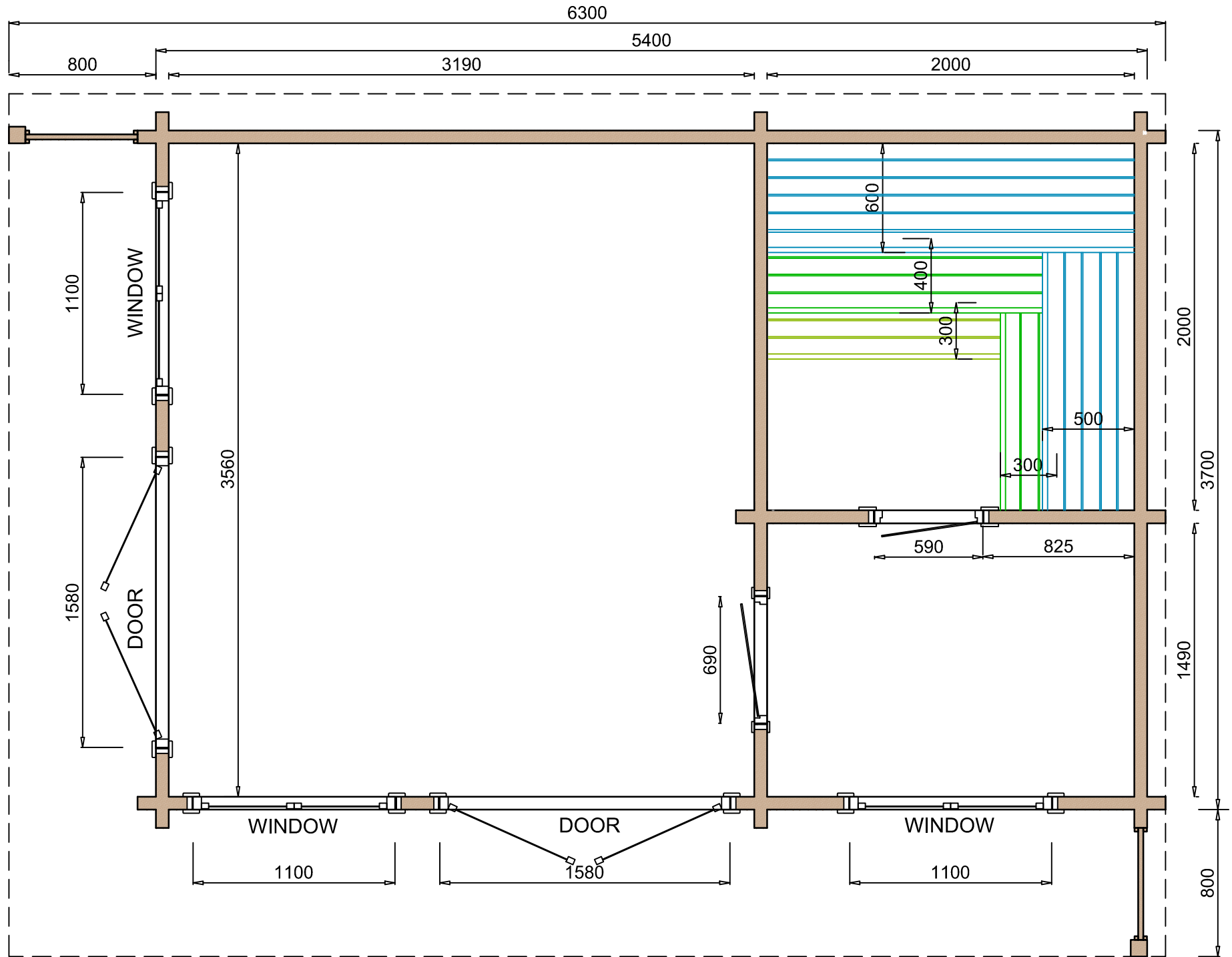

CROSS-SECTION

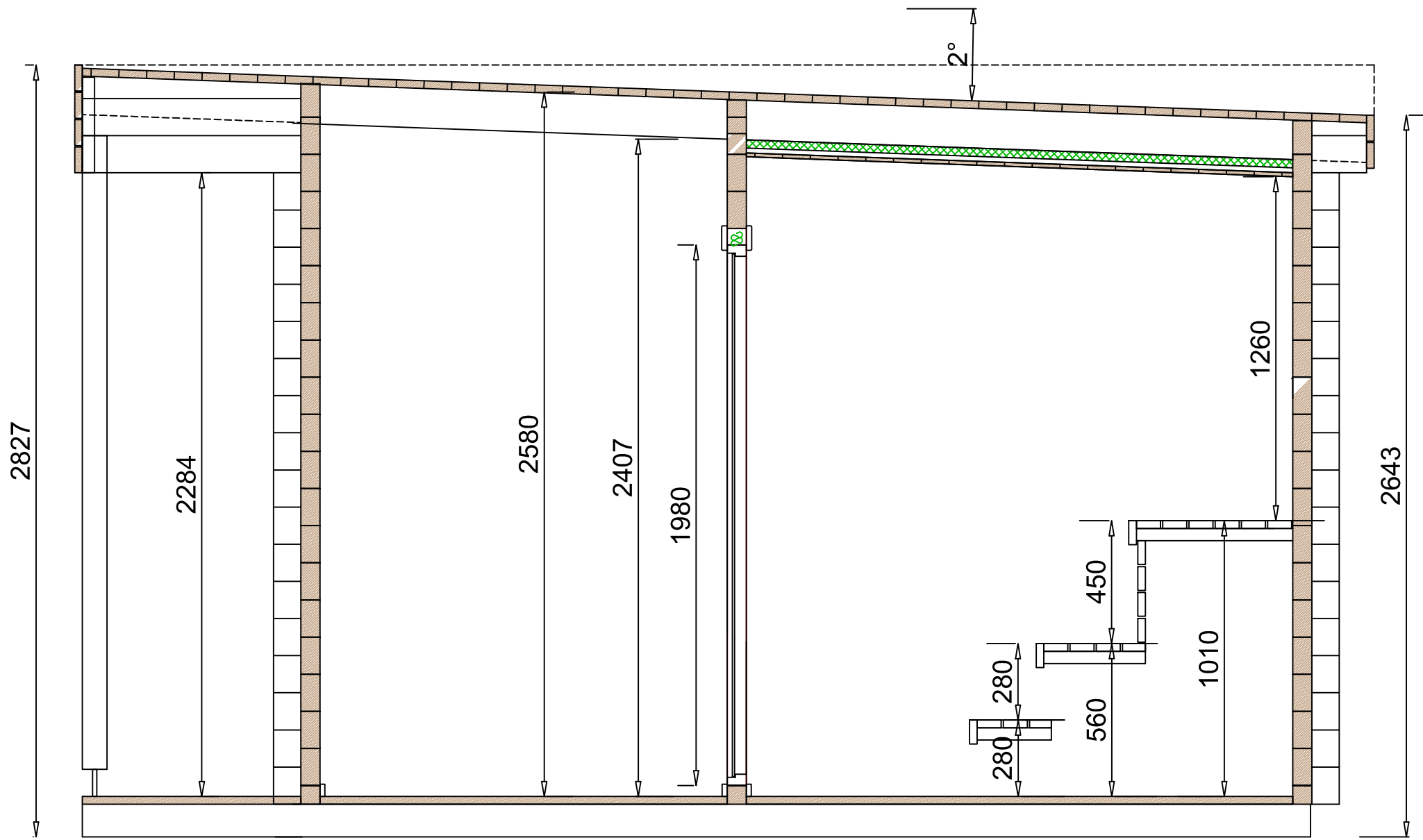

FLOOR FRAME

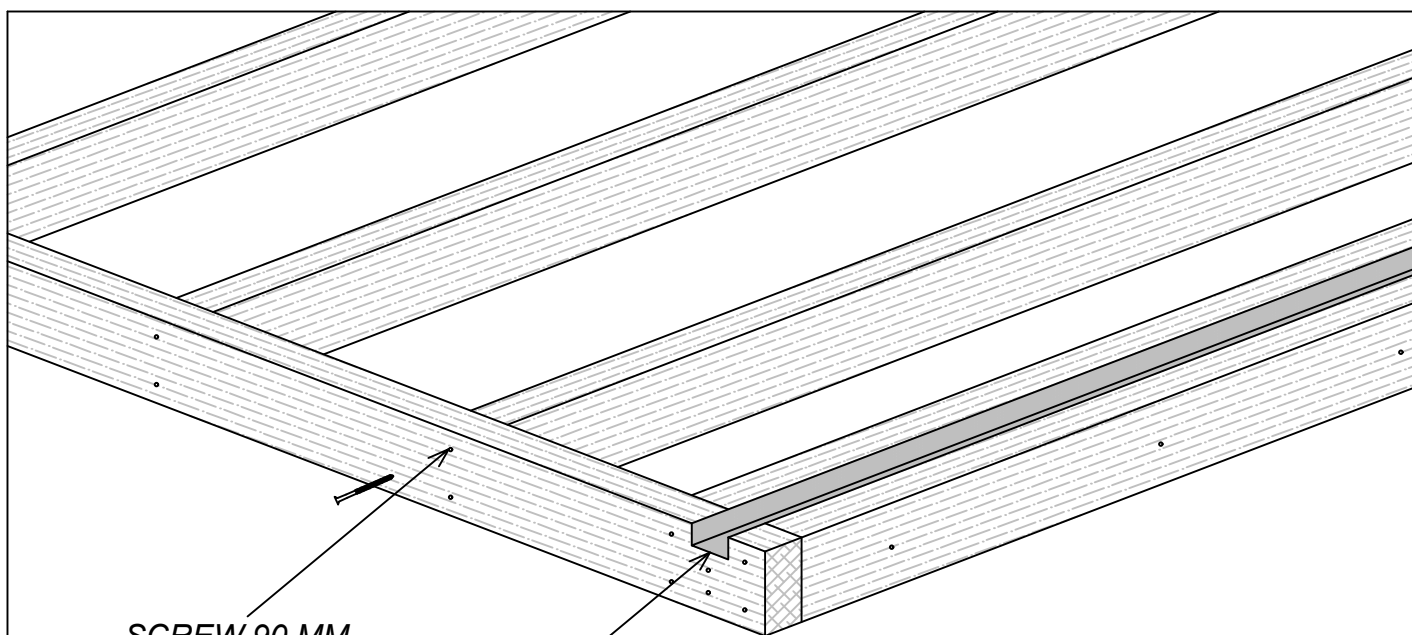

SCREW 90 MM

CUTOUT 45x25
FOR WATER DRAINAGE

INSTALL THE WATER DRAINAGE DETAIL BEFORE FLOOR BOARDS
FIX WITH FLOOR MOULDING

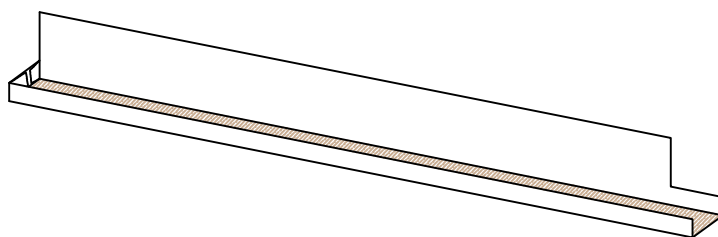

FLOOR BOARDS

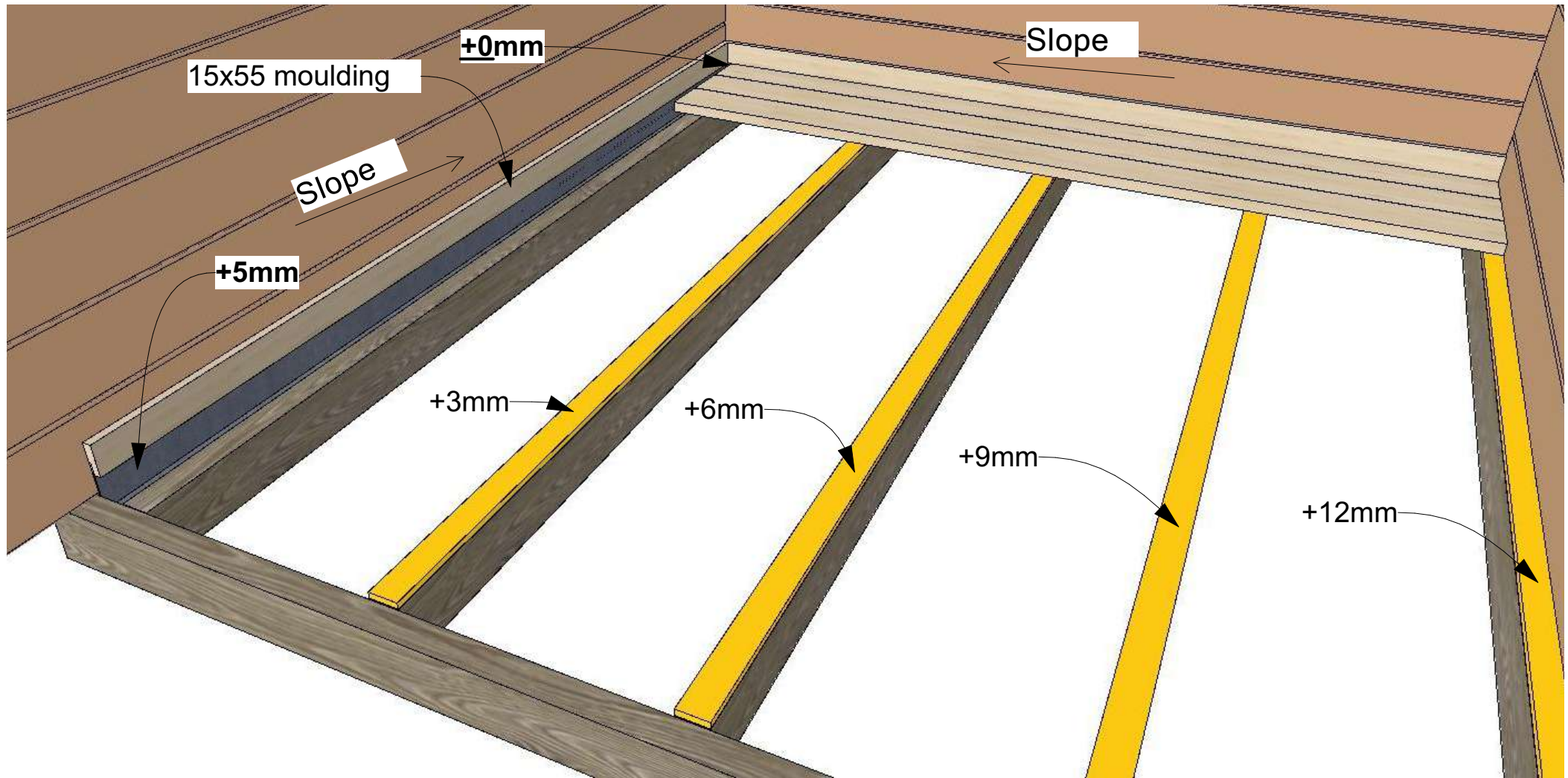

FLOOR AND DECKING BOARD

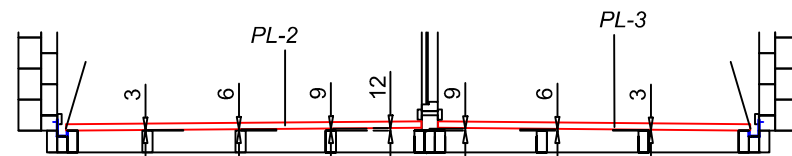
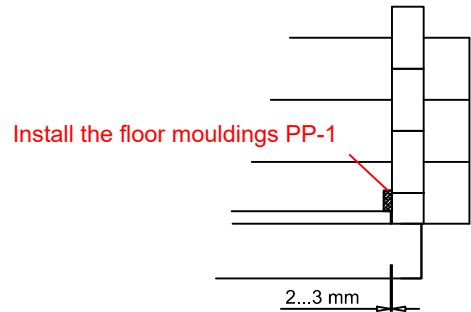
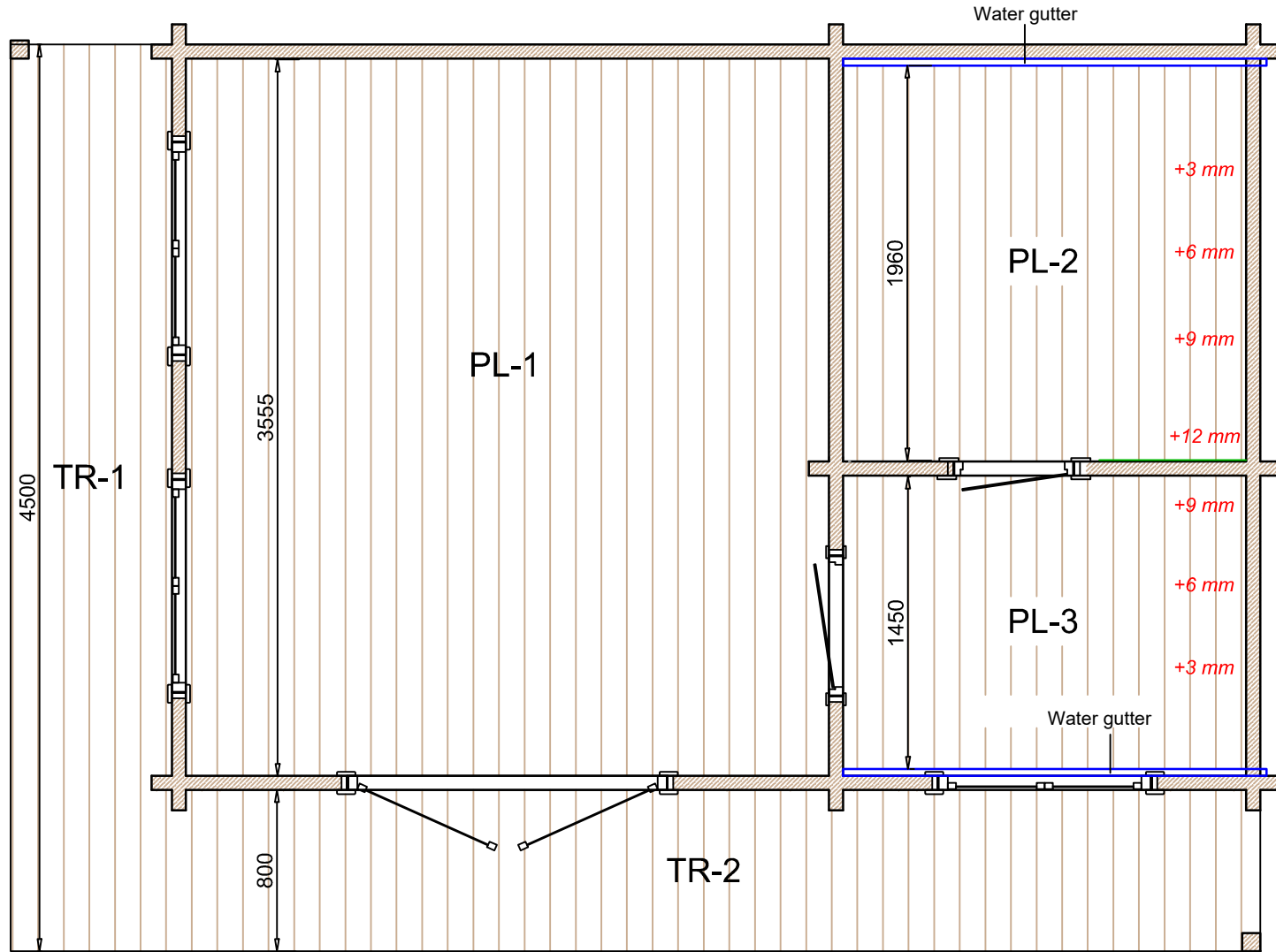

FIX THE SLOPE DETAILS 3, 6, 9, 12 MM BEFORE INSTALLING THE FLOOR BOARDS

FIRST ROW

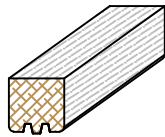
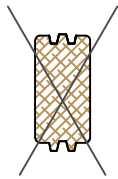

Use rubber hammer and hammer block

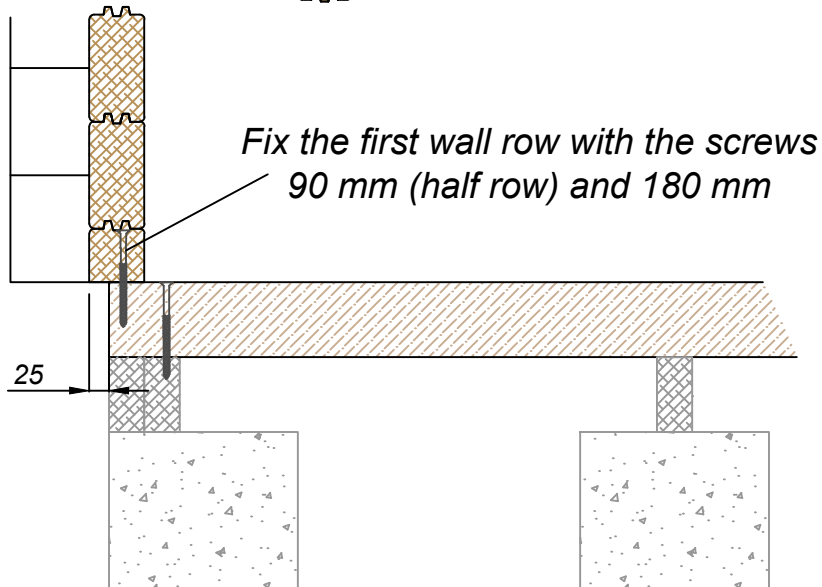

THREADED RODS

WHEN INSTALLING THE WALL LOGS,
PLEASE CHECK THAT ALL THE HOLES ARE DRILLED!

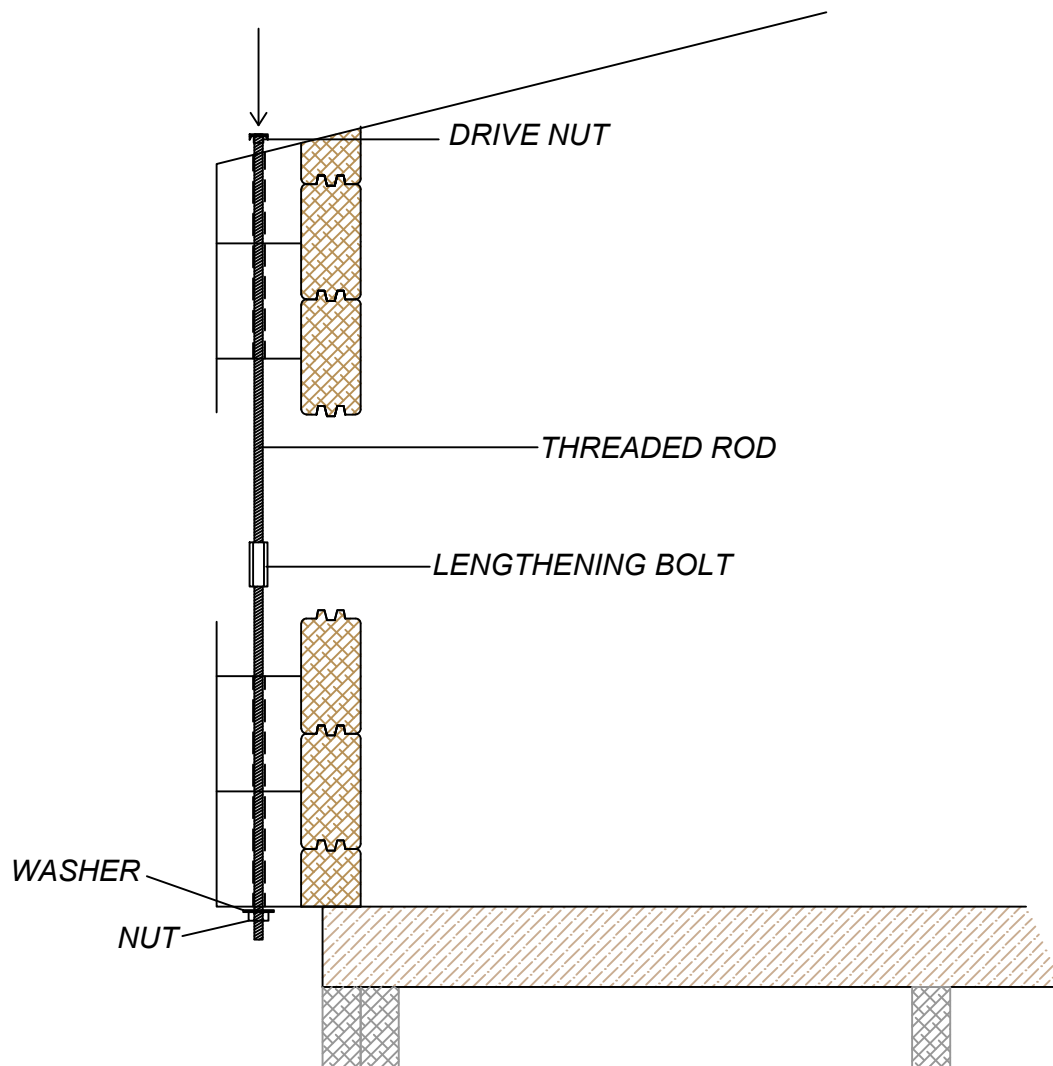

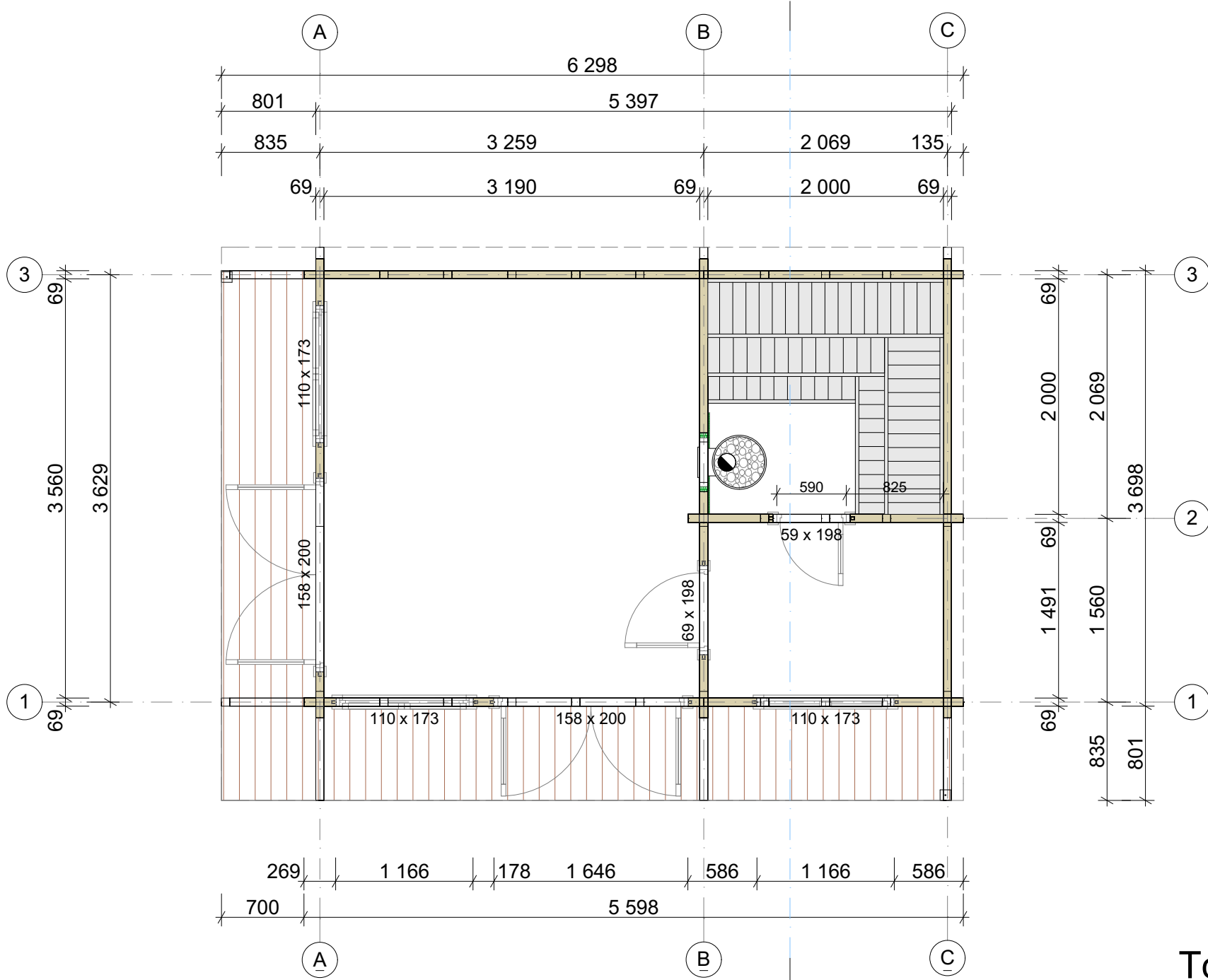

Top view

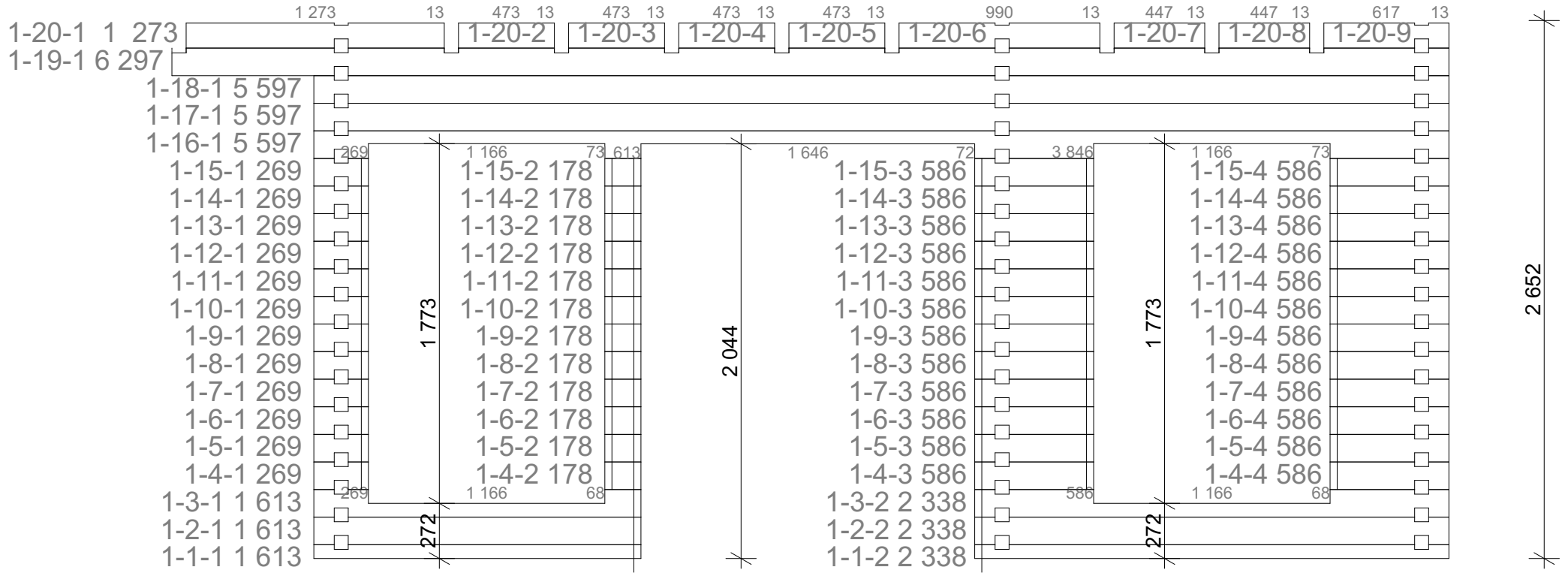

A

B

C

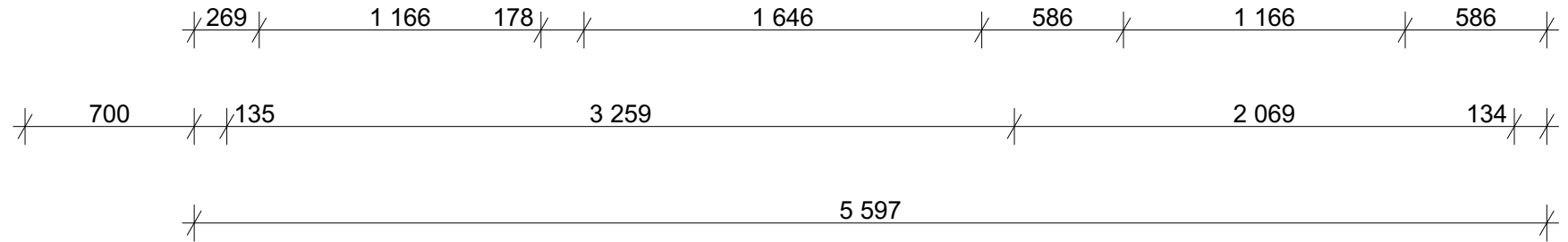

WALL 1

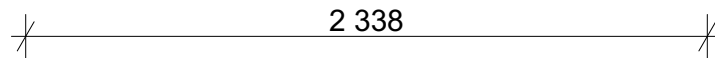
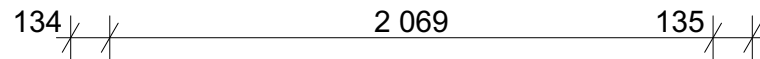
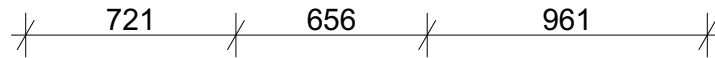
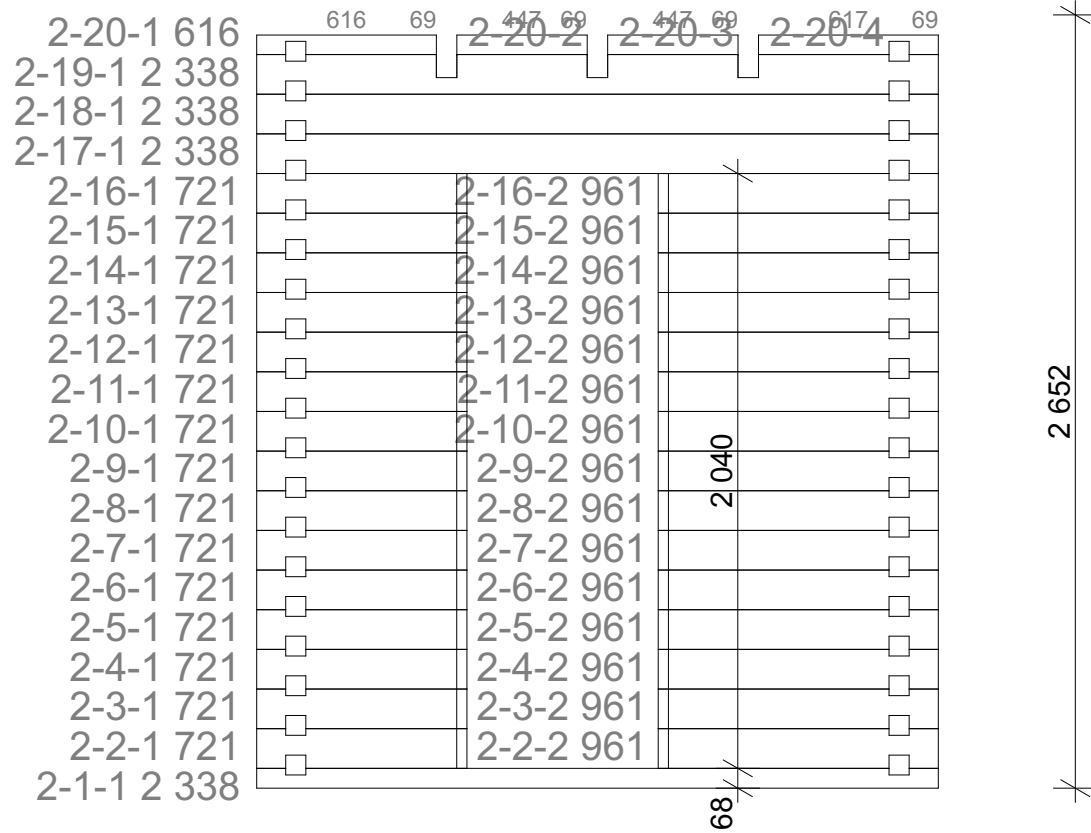

WALL 2

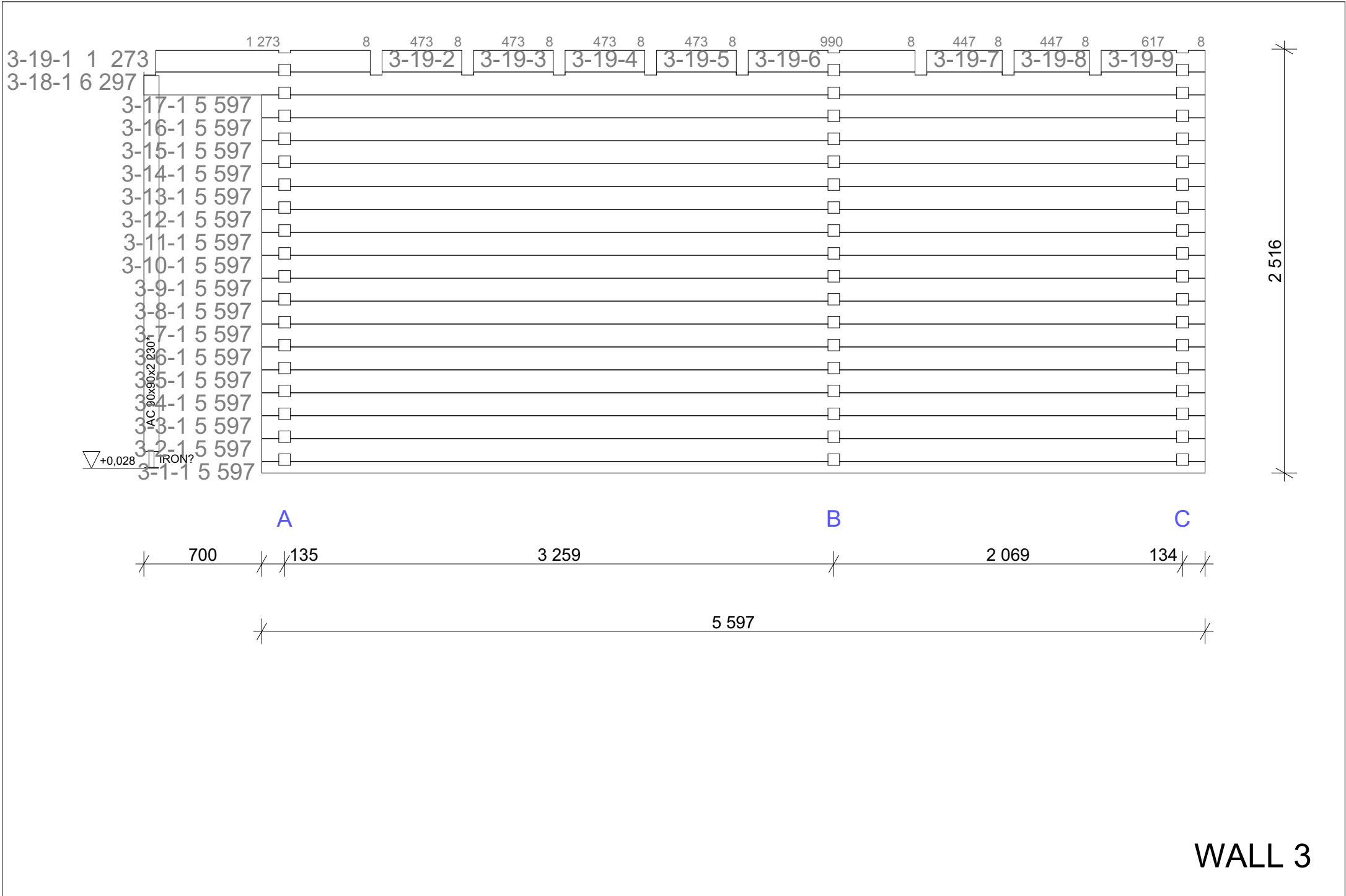

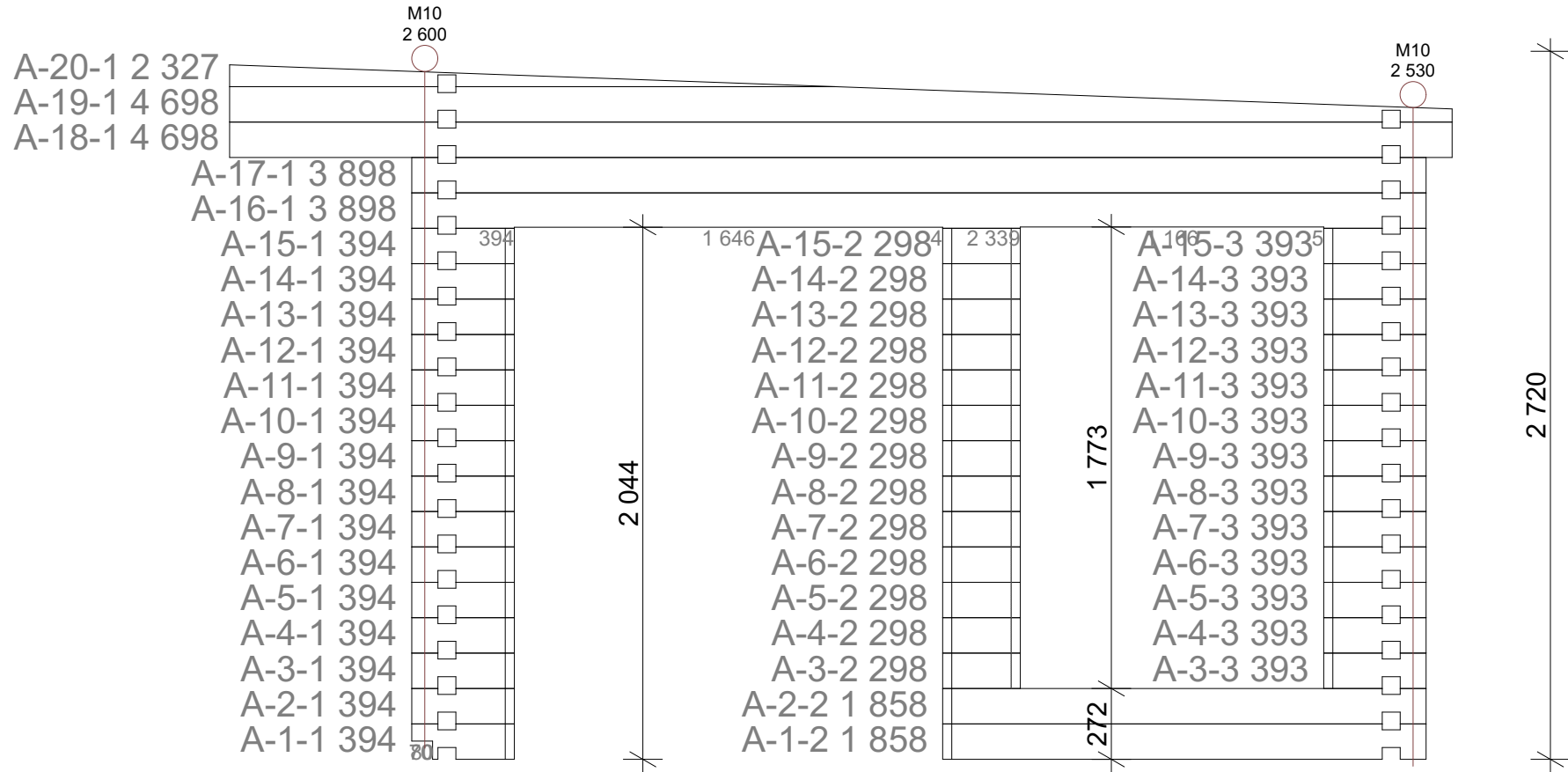

WALL A

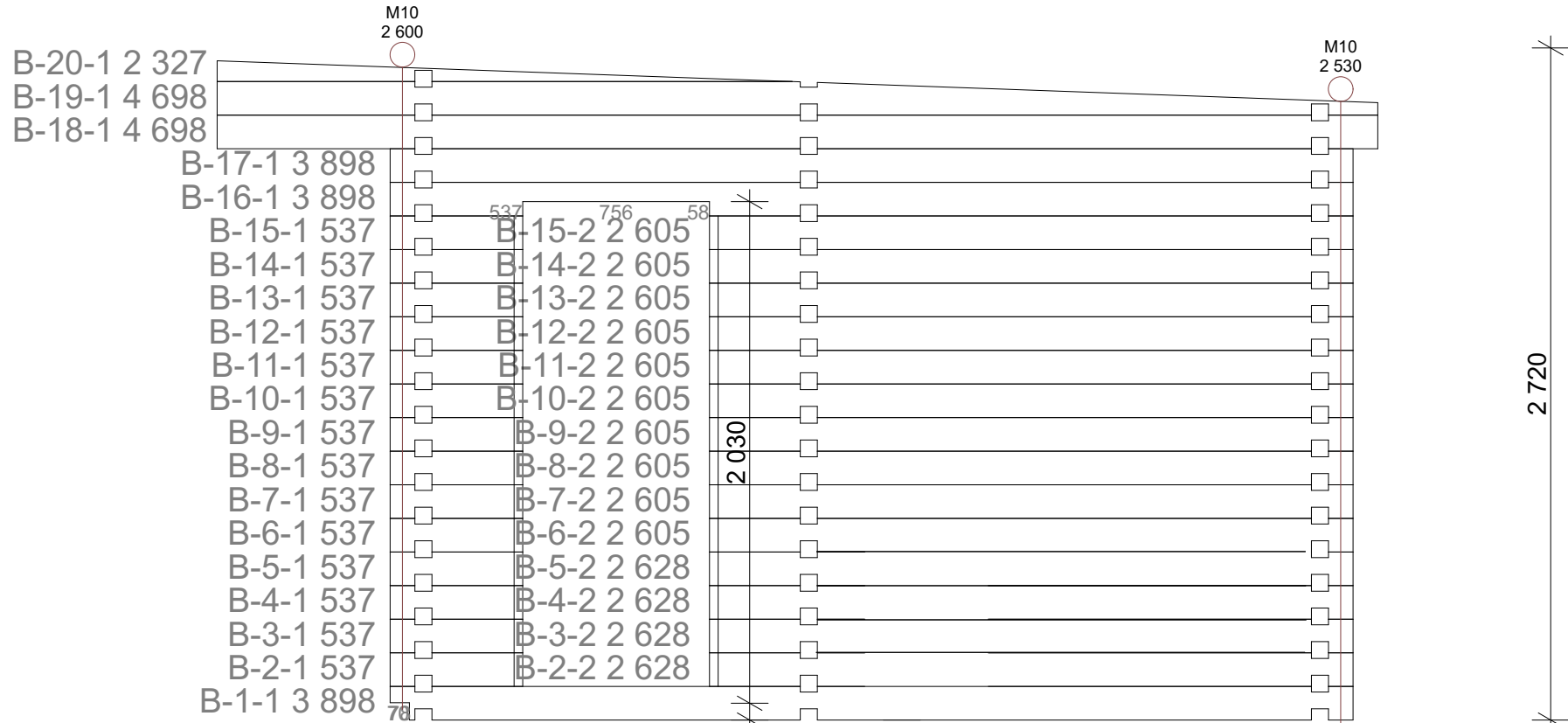

2720

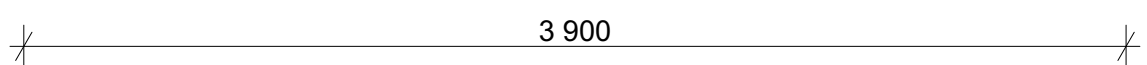
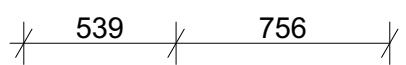

WALL B

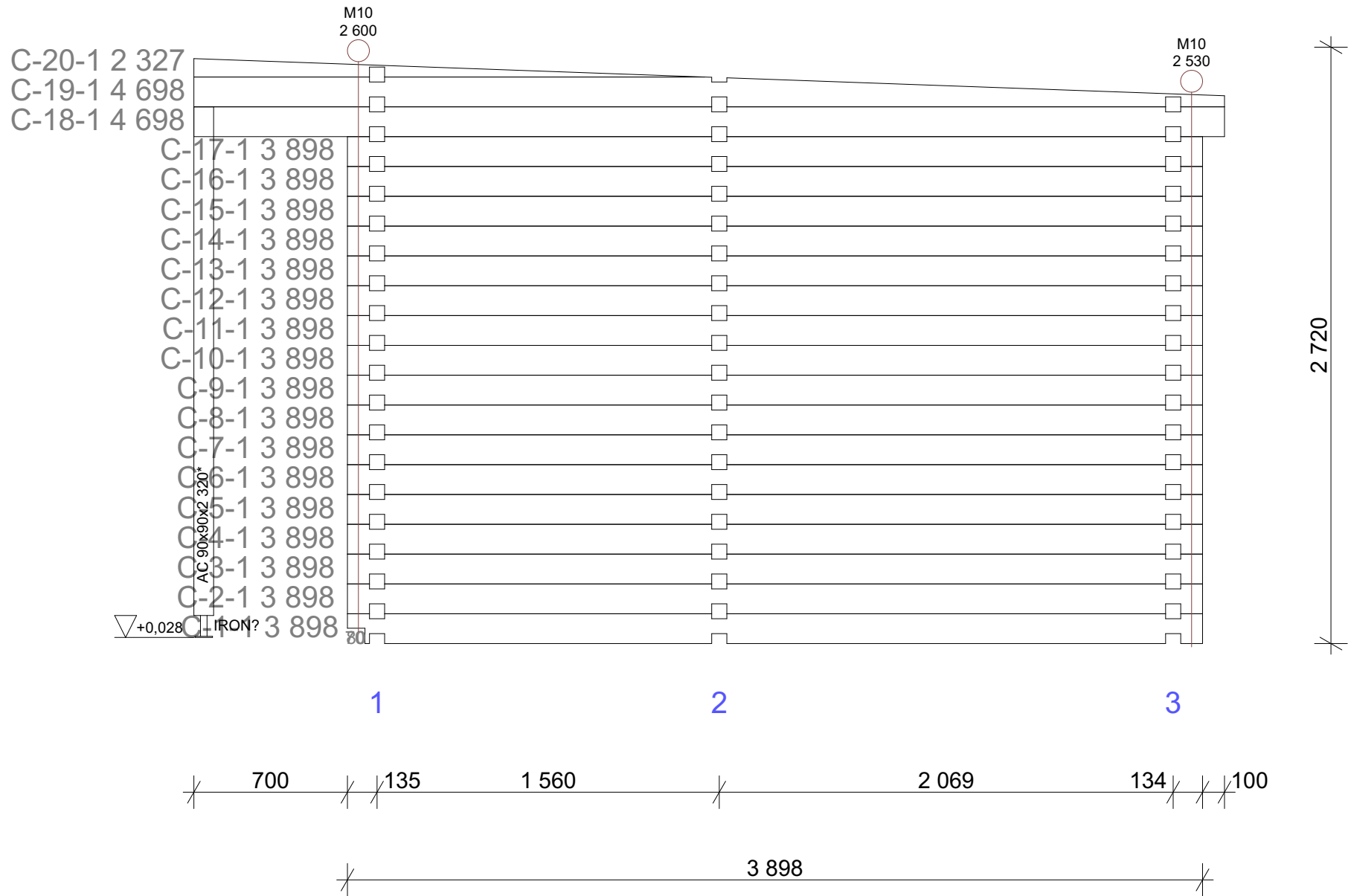

WALL C

CUTTINGS ABOVE AND UNDER THE DOOR (IF NECESSARY)



Horizontal cut



Make the vertical cuts



Roof board in two pcs
4628+1670 mm

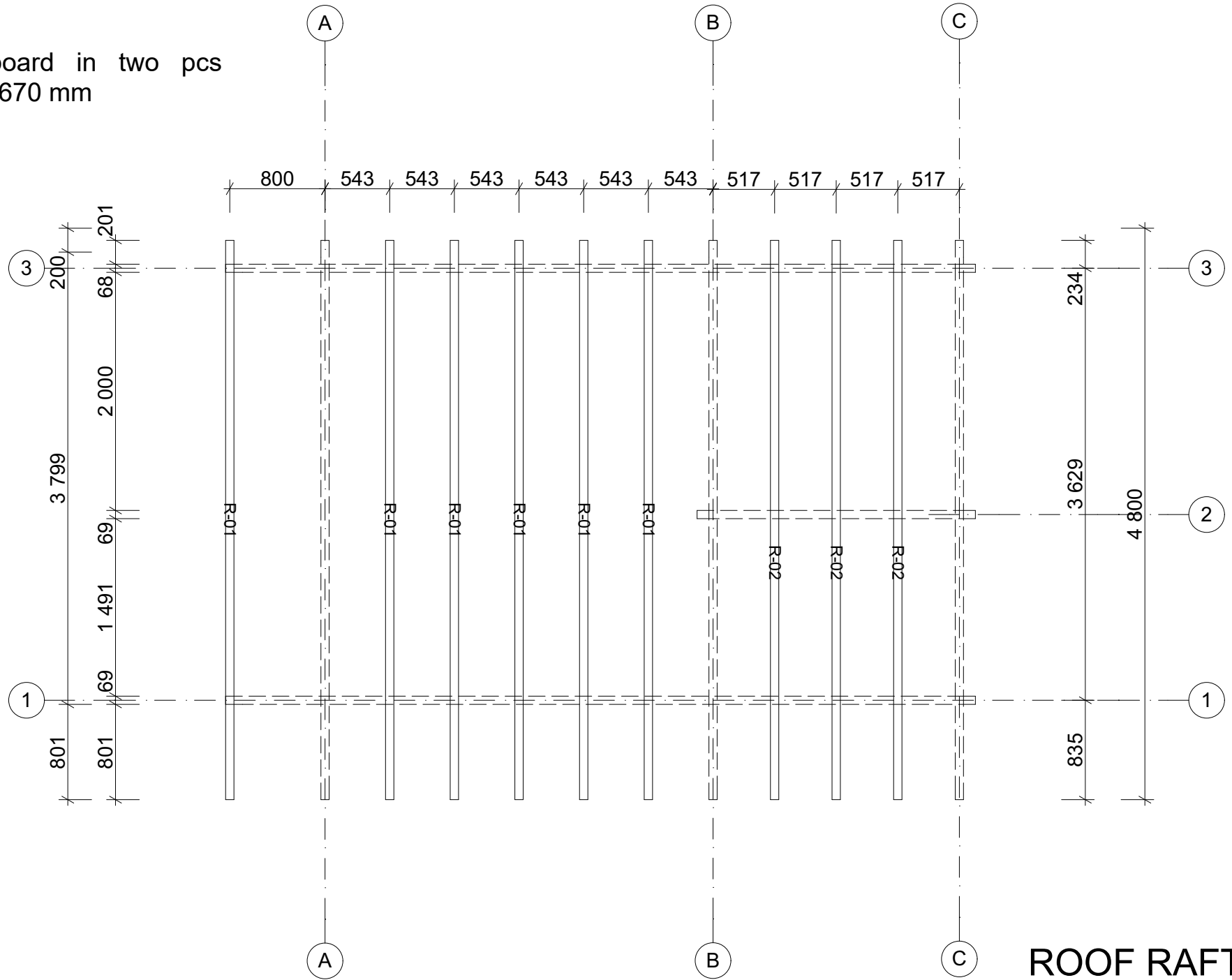

ROOF RAFTERS

Fix the roof boards with 75 mm nail (2 nails per connection)

ROOF RAFTERS / ROOF BOARDS

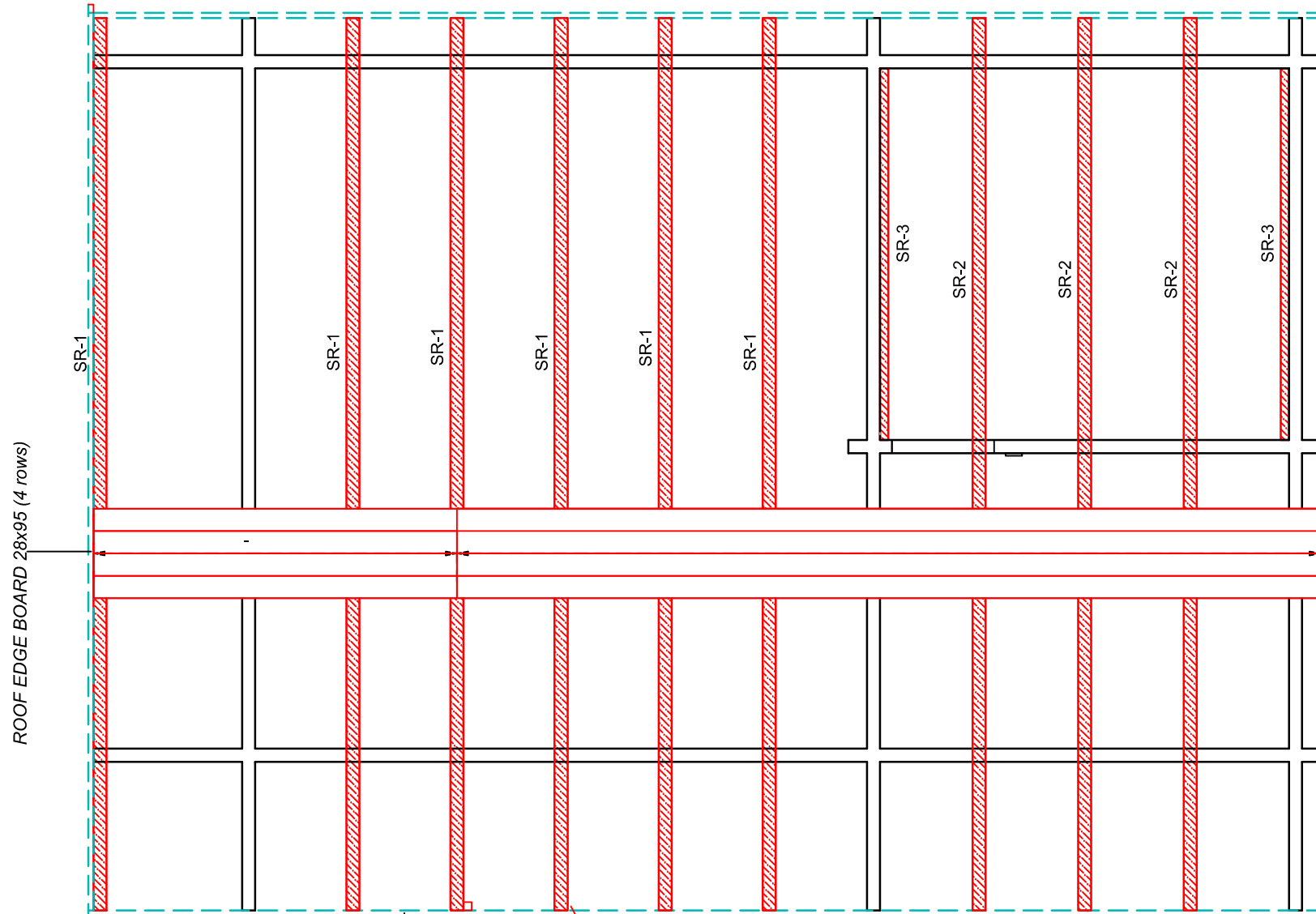

ROOF EDGE BOARD 28x95 (4 rows)

SR-1

SR-1

SR-1

SR-1

SR-1

SR-1

SR-3

SR-2

SR-2

SR-2

SR-3

ROOF EDGE BOARD 28x95 (RL-1) 4 ROWS
CUT TO RIGHT LENGTH WHEN ASSEMBLING

USE 45x45x330 DETAILS (RL-2) FOR FIXING THE RL-1

Roof rafters

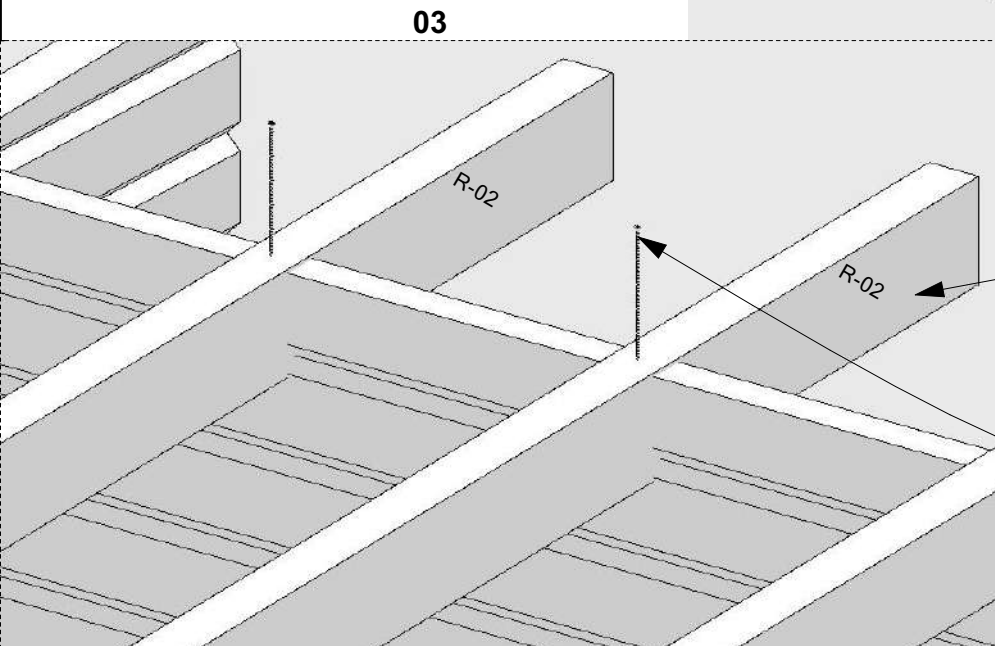
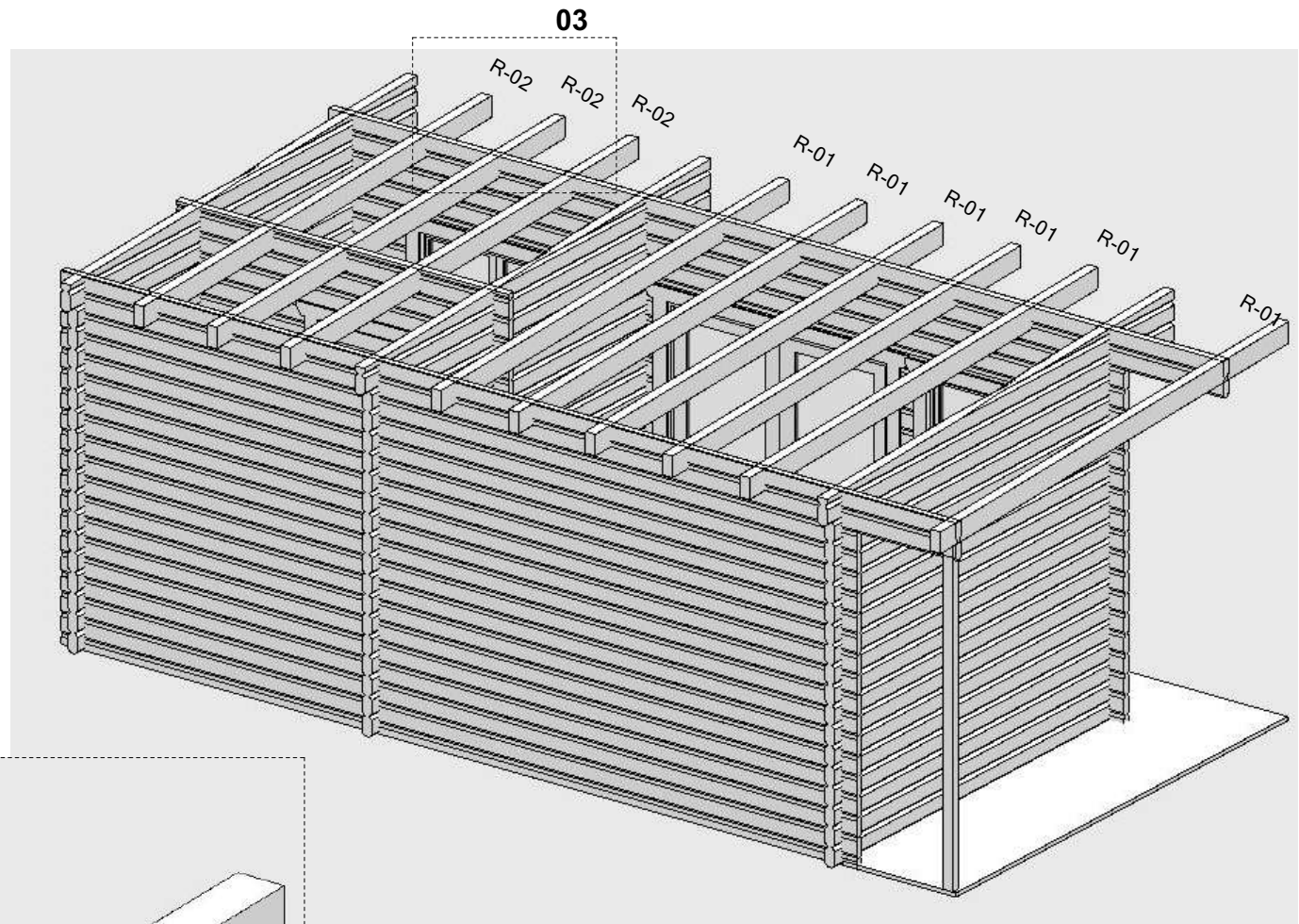

Rafter 70x145mm

Screw 180mm

Roof edges

○ Fix the special profile

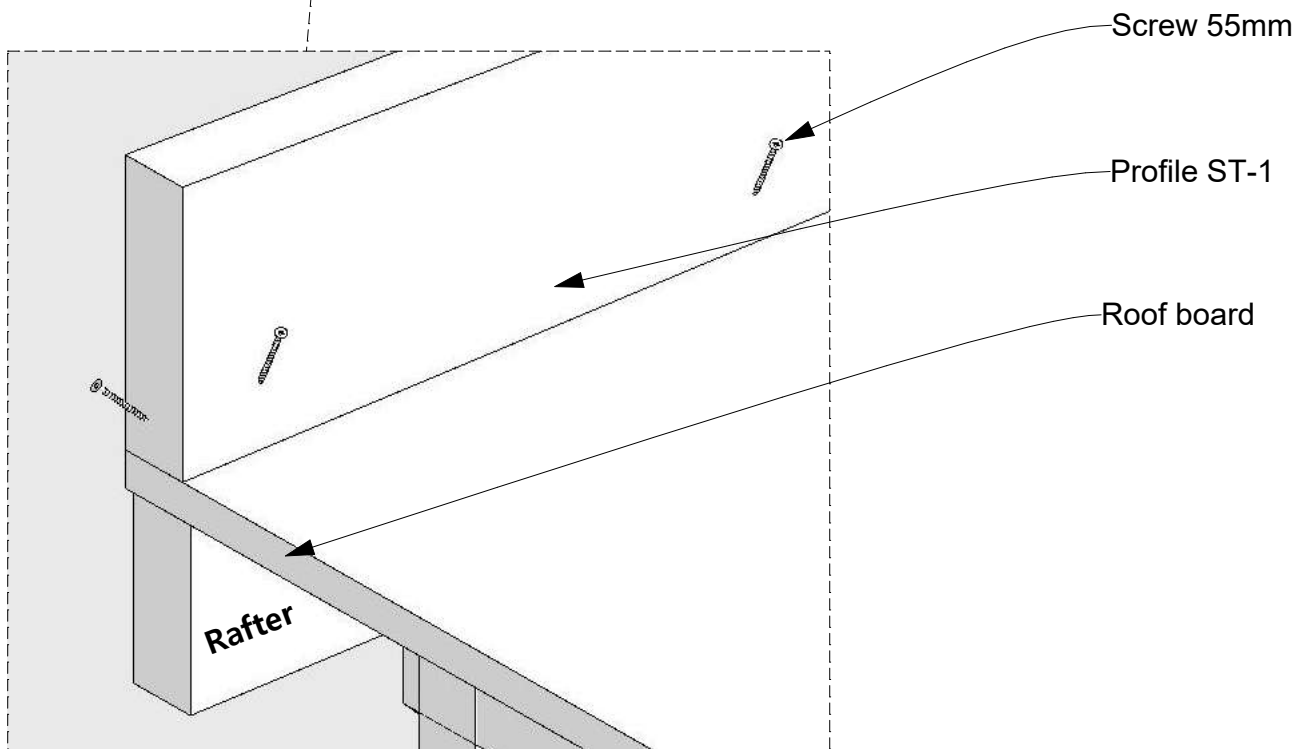
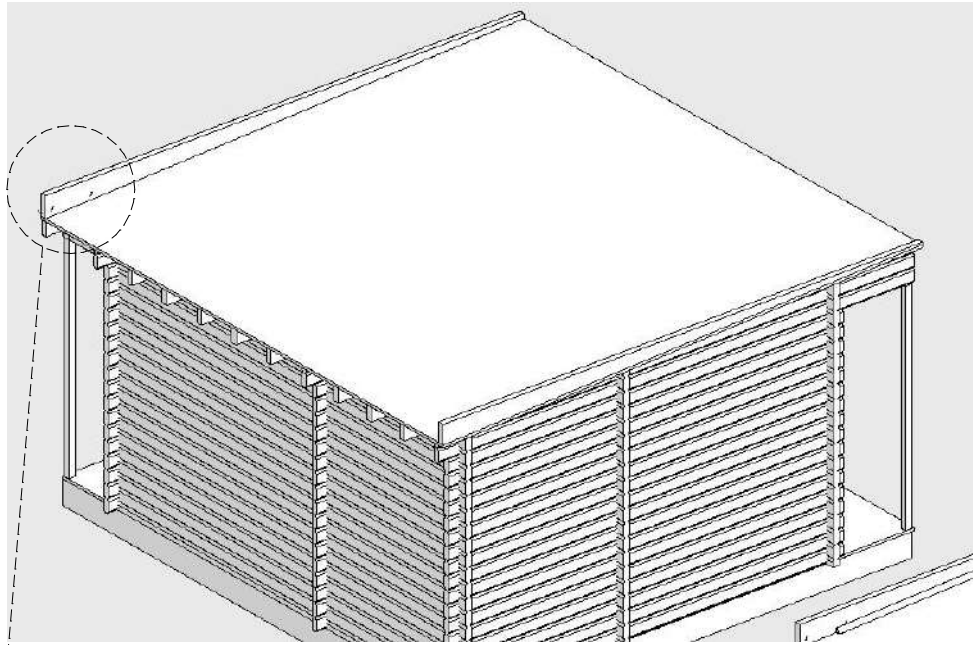

Fix the profile ST-1 45x171 on top of the roof boards (sides)

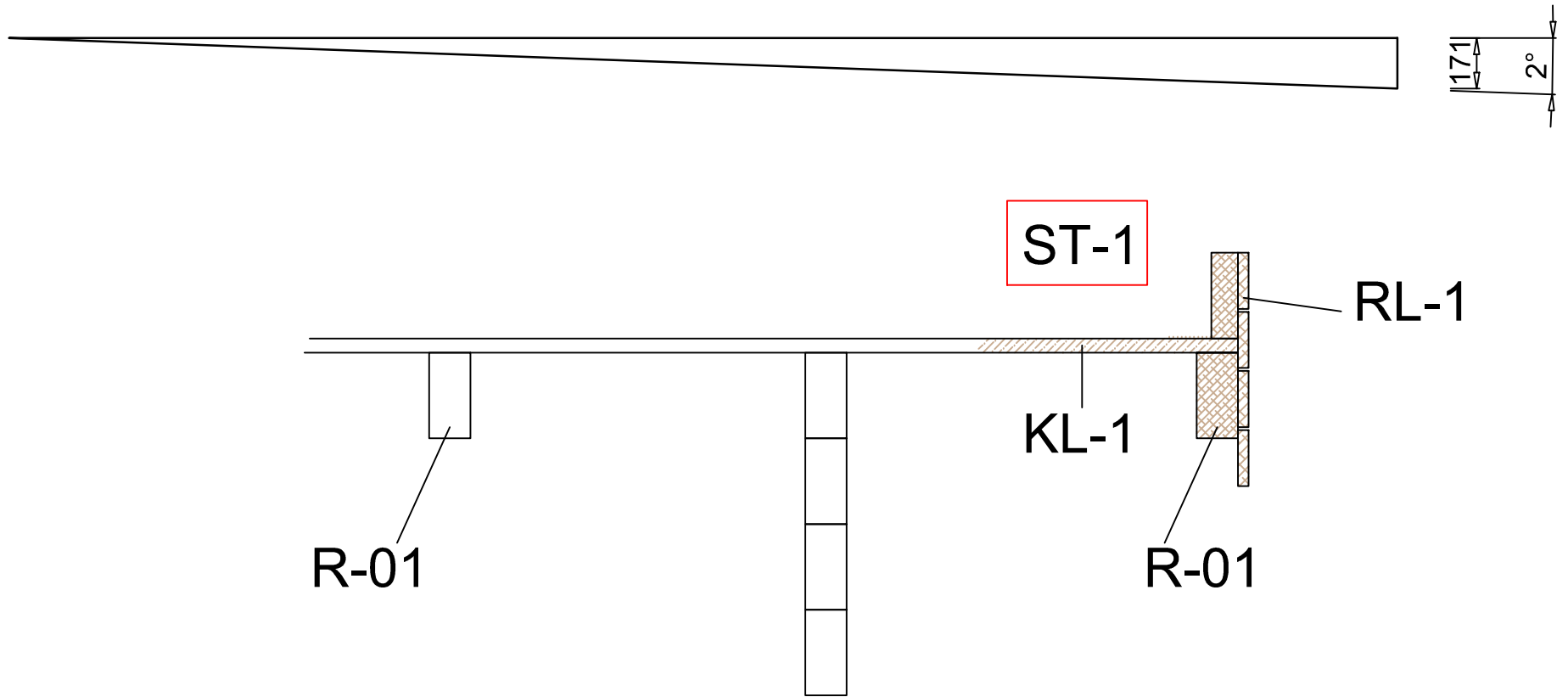

DOOR AND WINDOW MOULDINGS 18x95

DOOR 1580x2000

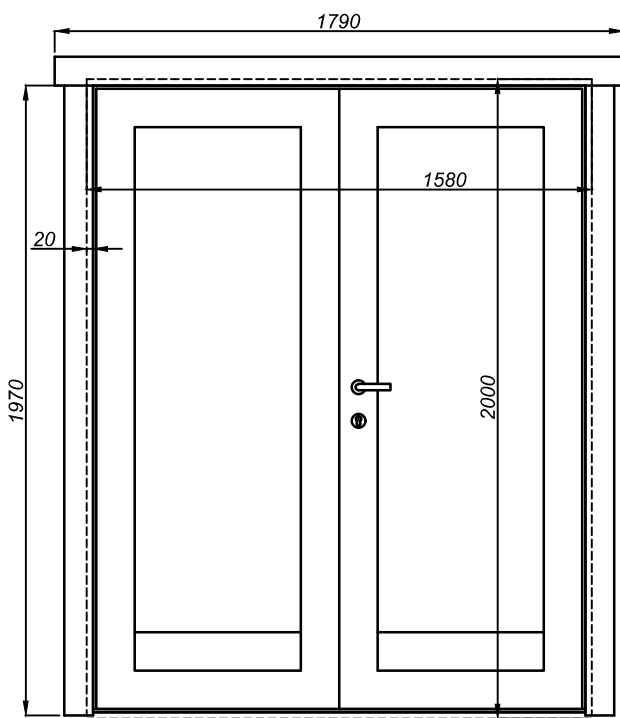

Metal interior moulding to the floor

GLASS DOOR 690x1980

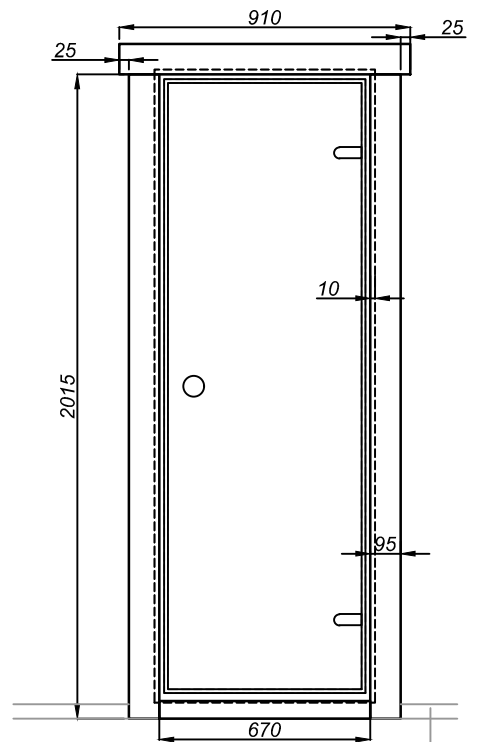

FLOOR MOULDING 15x55

GLASS DOOR 590x1980

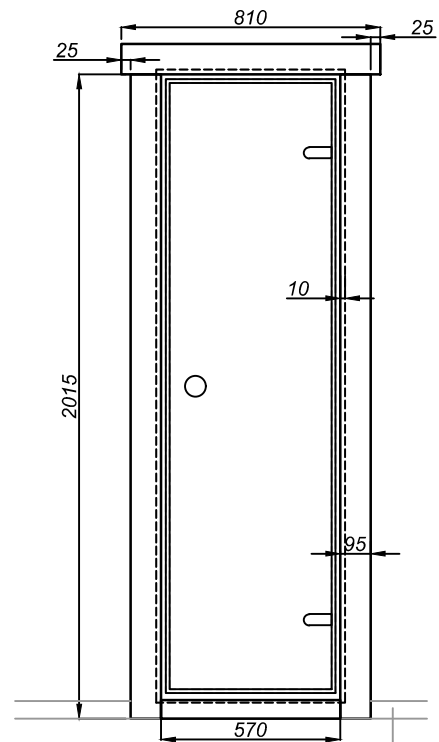

FLOOR MOULDING 15x55

WINDOW 1100x1729

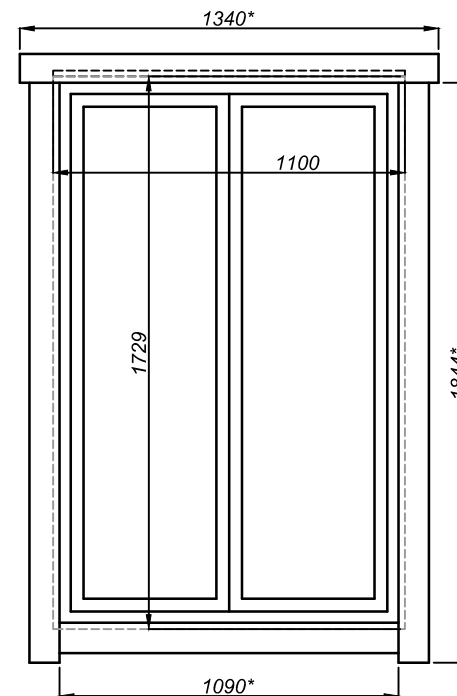

GRID WALL

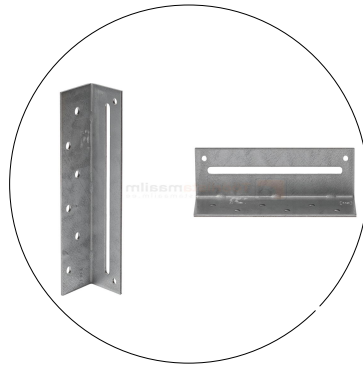

Adjustable
bracket
35x35*130

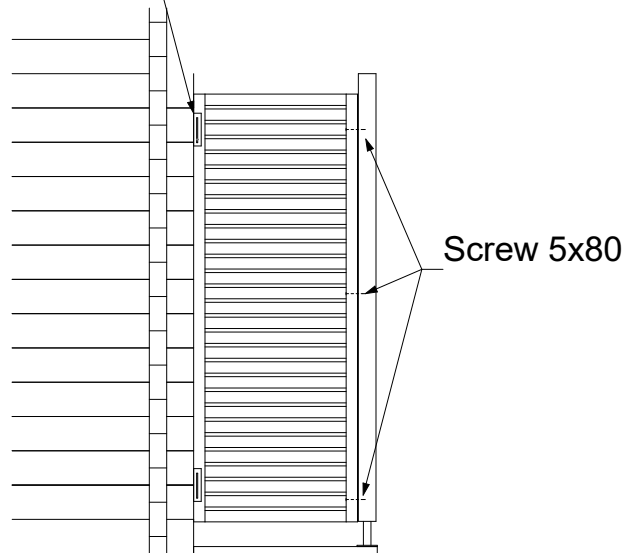

Adjustable bracket
Washer M5
Screw 5x40

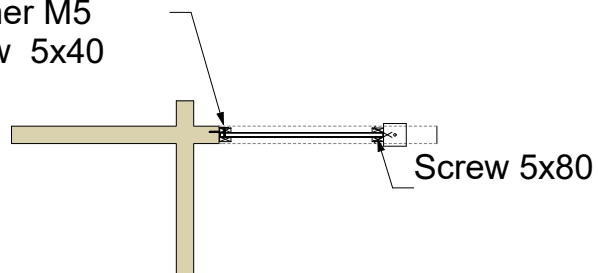

Bench set

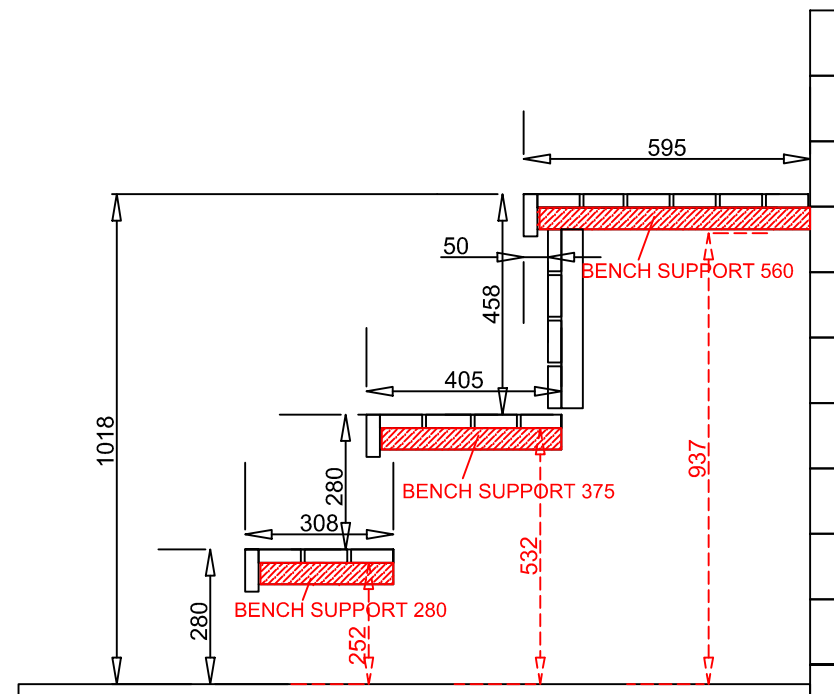
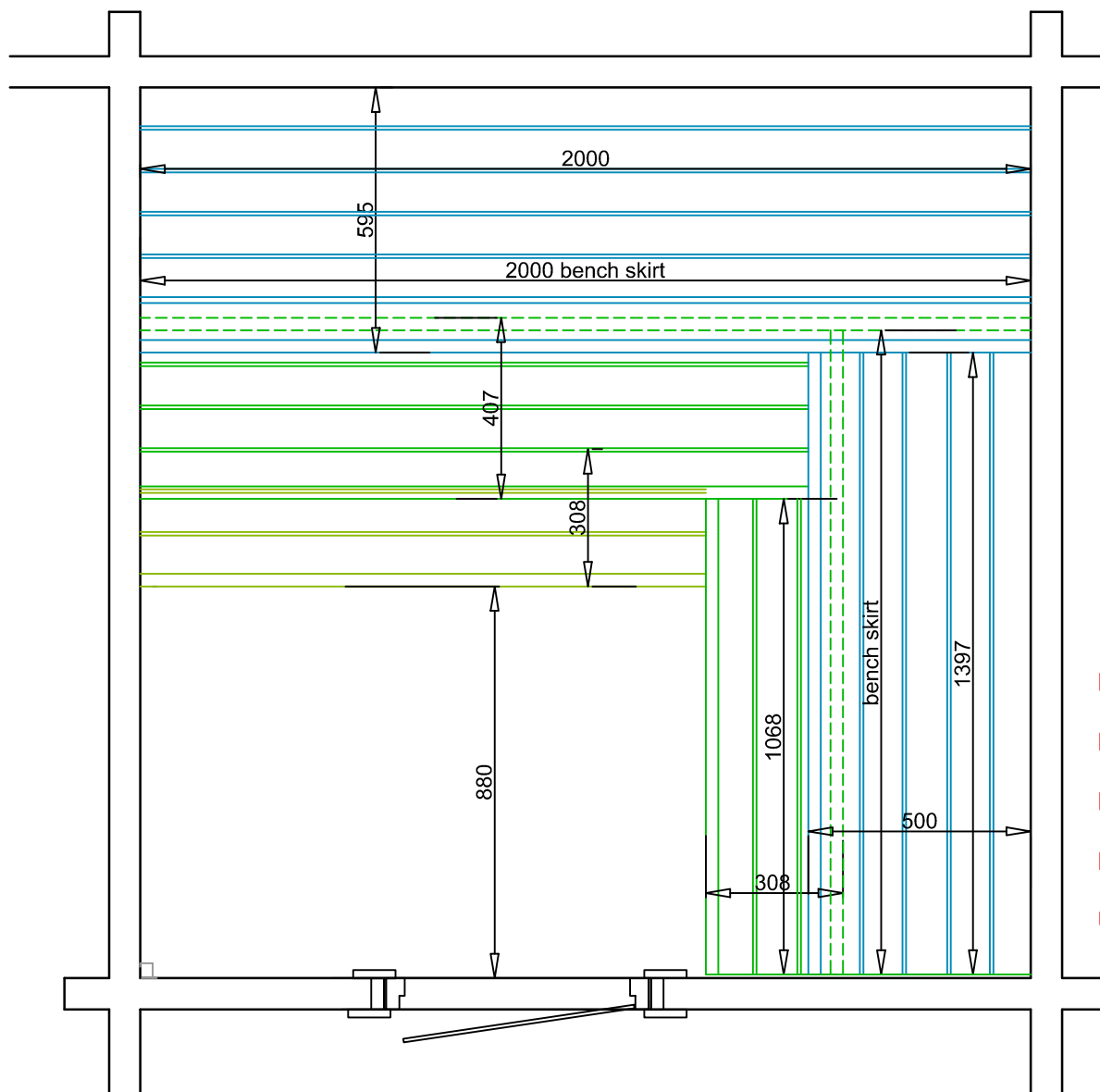

- FIX THE HORIZONTAL SUPPORTS WITH SCREWS TO THE WALL
- LIFT THE BENCHES TO THE SUPPORTS
- FIX THE BENCH SKIRTS UNDER THE UPPER BENCH
- FIX THE BENCHES TO THE SUPPORTS WITH SCREWS
- USE VERTICAL SUPPORT POST IN THE MIDDLE

Benches

- 1. Fix the bench supports to the walls



Screws 90mm

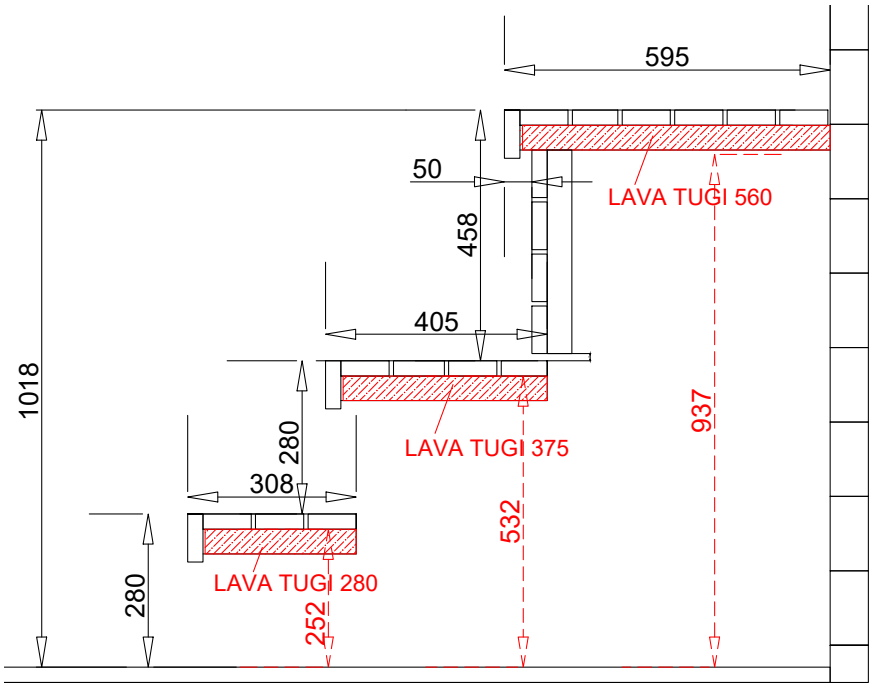
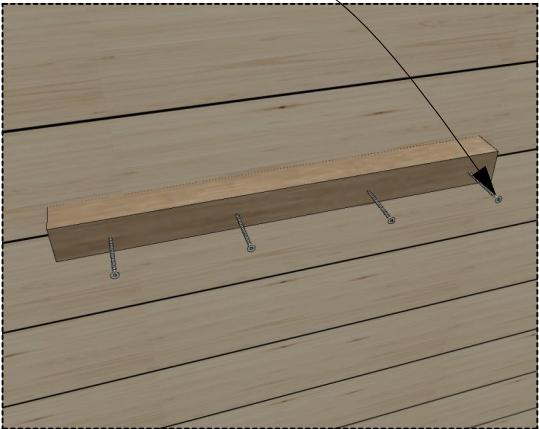

USE GLUE BETWEEN SUPPORT AND WALL

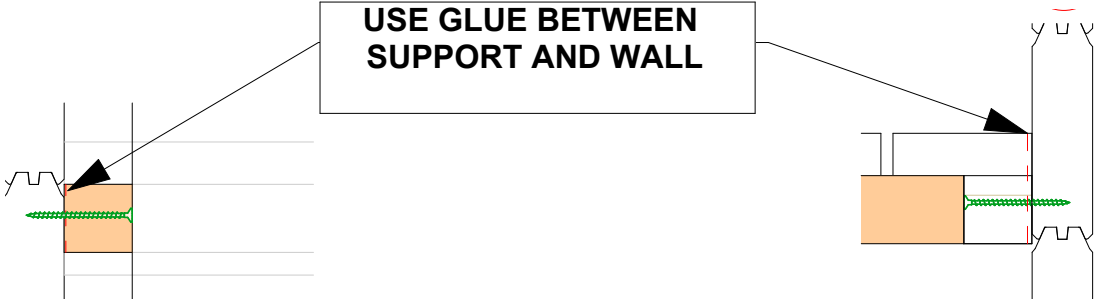

Lift the benches on top of the supports

2.

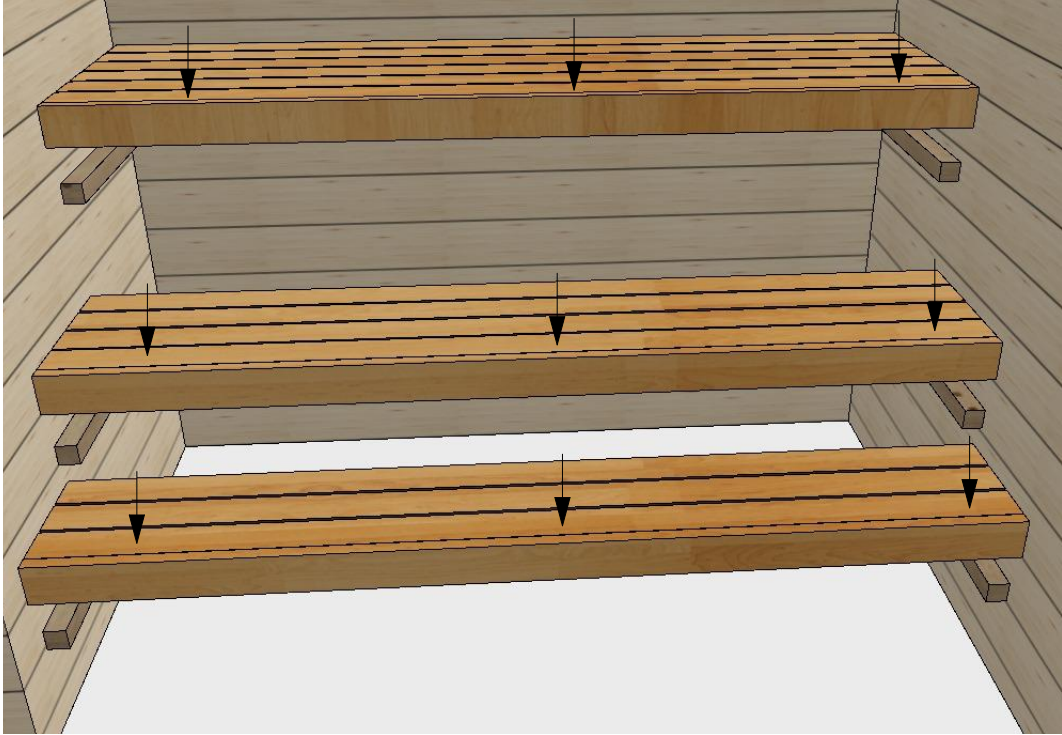

FIX THE BENCHES UNDERNEATH (MAX 60 MM SCREWS)

3. FIX THE SUPPORTS FOR L-BENCH

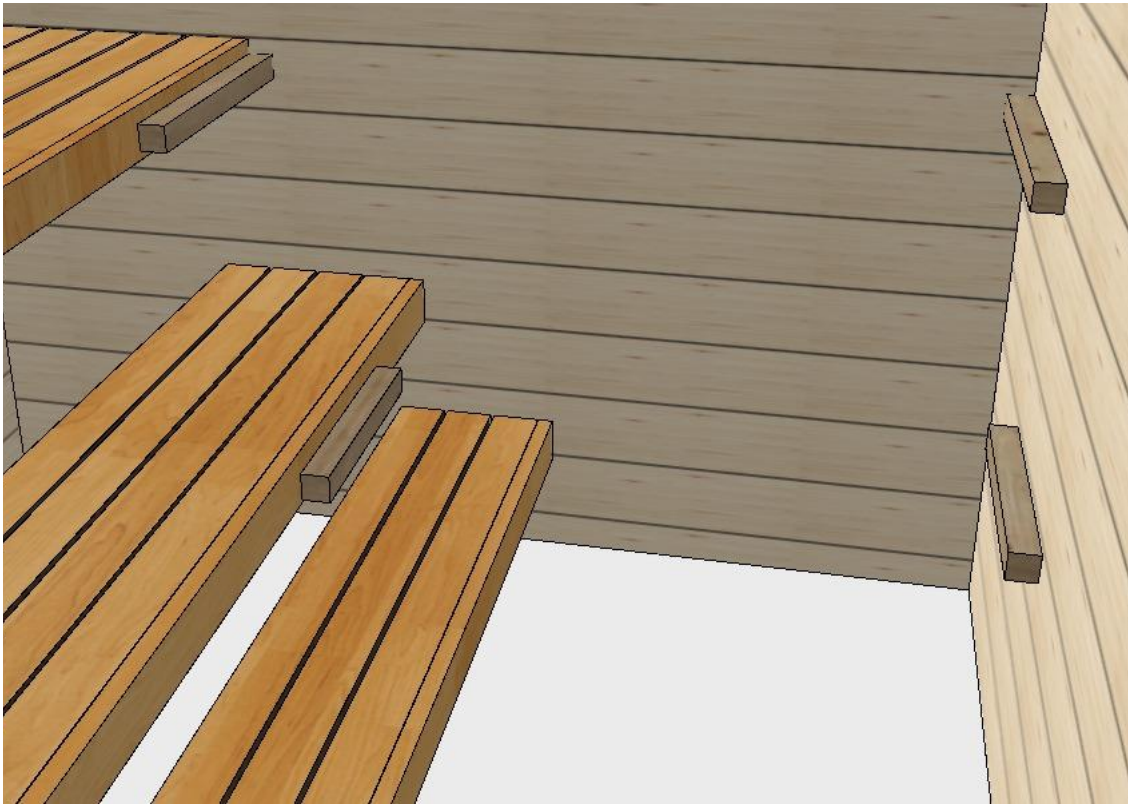

4. Lift the benches on top of the supports

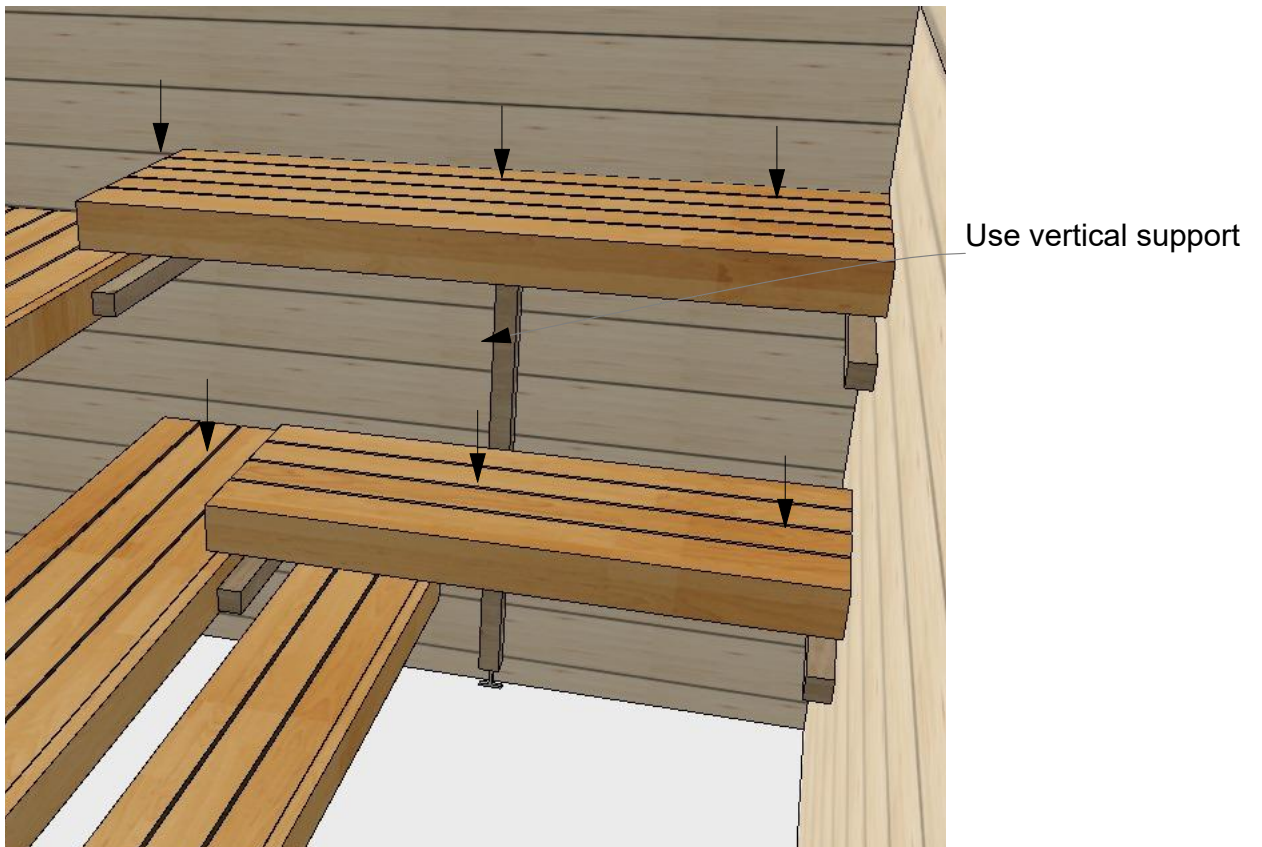

5.

Fix the bench skirts

